

Operating Instructions

FLAWSIC600-XT

Ultrasonic Gas Flow Meter



Described product

Product name: FLOWSIC600-XT

Manufacturer

Endress+Hauser SICK GmbH+Co. KG
 Bergener Ring 27
 01458 Ottendorf-Okrilla
 Germany

Legal information

This work is protected by copyright. Any rights derived from the copyright shall be reserved for Endress+Hauser SICK GmbH+Co. KG. Reproduction of this document or parts of this document is only permissible within the limits of the legal determination of Copyright Law.
 Any modification, abridgment or translation of this document is prohibited without the express written permission of Endress+Hauser SICK GmbH+Co. KG.
 The trademarks stated in this document are the property of their respective owner.

© Endress+Hauser SICK GmbH+Co. KG. All rights reserved.

Original document







This document is an original document of Endress+Hauser SICK GmbH+Co. KG.



Glossary

ATEX	ATEX: Atmosphères Explosifs: Abbreviation for European standards that govern safety in potentially explosive atmospheres
CSA	Canadian Standards Association (www.csa.ca)
DC	Direct Current
EVC	Electronic Volume Corrector
HF	High frequency, e.g. HF pulse
IEC	International Electrotechnical Commission
IECEX	IEC system for certification in accordance with standards for devices for use in potentially explosive atmospheres
IPxy	Ingress Protection: Degree of protection of a device in accordance with IEC/DIN EN 60529; x specifies the protection against contact and impurities, y protection against moisture.
NAMUR	Abbreviation for "Normen-Arbeitsgemeinschaft für Mess- und Regeltechnik in der chemischen Industrie", now "Interessengemeinschaft Automatisierungstechnik der Prozessindustrie" (www.namur.de)
pTZ	Volume conversions as function of the pressure, temperature and under consideration of the real gas factor
RTC	Real time clock

Warning symbols

	IMMEDIATE HAZARD of severe injuries or death
	Hazard (general)
	Hazard by voltage
	Hazard in potentially explosive atmospheres
	Hazard by explosive substances/mixtures
	Hazard by unhealthy substances
	Hazard by toxic substances

Warning levels / signal words

DANGER

Risk or hazardous situation which *will* result in severe personal injury or death.

WARNING

Risk or hazardous situation which *could* result in severe personal injury or death.

CAUTION

Hazard or unsafe practice which *could* result in less severe or minor injuries.

NOTICE

Hazard which could result in property damage.

Information symbols



Information on product condition with regard to protection against explosions (general)



Information on product characteristics related to European Directive ATEX



Information on product characteristics related to explosion protection in accordance with the IECEx scheme.



Important technical information for this product



Important information on electric or electronic functions



Nice to know



Supplementary information



Link referring to information at another place

1	Important information	11
1.1	About this document	12
1.2	Important safety information	12
1.2.1	Hazards due to hot, corrosive and explosive gases, or high pressure	12
1.2.2	Hazard through heavy loads	12
1.2.3	Hazard through electromagnetic interference	13
1.3	Intended use	13
1.3.1	Product identification	13
1.3.2	Purpose of the device	13
1.3.3	Operation in potentially explosive atmospheres	14
1.3.4	Operation in pressure applications	15
1.3.5	Restrictions of use	15
1.4	Responsibility of user	16
1.4.1	Designated users	16
1.4.2	Correct use	17
1.4.3	Danger identification on device	17
1.4.4	Special local conditions	17
1.4.5	Retention of documents	17
2	Product description	19
2.1	System components	20
2.1.1	Meter body	20
2.1.2	Ultrasonic transducers	21
2.1.3	Signal Processing Unit	21
2.1.4	Integrated pressure and temperature sensor	21
2.2	Measuring principle	22
2.2.1	Determination of gas velocity	22
2.2.1.1	Determination of transit time of ultrasonic signals	22
2.2.1.2	Determination of path velocity	22
2.2.1.3	Determination of flow rate	23
2.2.1.4	Determination of volumetric flow a. c.	23
2.3	Correction of the effect of pressure and temperature on the geometry of the meter body	23
2.3.1	Correction in FLOWSIC600-XT electronics	23
2.3.2	Correction outside the FLOWSIC600-XT electronics (flow computer)	23
2.4	Features and applications	25
2.4.1	FLOWSIC600-XT	25
2.4.2	FLOWSIC600-XT 2plex	25
2.4.3	FLOWSIC600-XT Quatro	26
2.4.4	FLOWSIC600-XT Forte	26
2.4.5	FLOWSIC600-XT C	27
2.4.6	FLOWSIC600-XT (non-custody transfer version)	27
2.4.7	FLOWSIC600-XT Gateway	27
2.5	Operating software FLOWgate™	29
2.5.1	Overview	29
2.5.2	System requirements	30
2.5.3	Access rights	30

2.6	Operating modes, meter states and signal output	31
2.6.1	Measuring mode	31
2.6.2	Air test mode	31
2.6.3	Configuration mode	31
2.7	Interfaces	32
2.7.1	Analog outputs	32
2.7.2	Digital outputs	32
2.7.3	Encoder totalizer	34
2.7.4	Serial data interfaces	35
2.7.5	Optical data interface	35
2.8	Totalizers	35
2.9	Diagnostics function i-diagnostics™	35
2.9.1	Fingerprint System	36
2.10	Data processing in FLOWSIC600-XT	38
2.10.1	Logbooks	38
2.10.2	Archives	39
2.10.3	Protection of parameters from undesired changes	40
2.11	Sealing	41
2.12	PowerIn Technology™	43
3	Installation	45
3.1	Hazards during installation	46
3.2	General information	47
3.2.1	Delivery	47
3.2.2	Transport	47
3.2.3	Water pressure test in the plant (optional)	47
3.3	Mechanical installation	48
3.3.1	Preparations	48
3.3.2	Choosing flanges, seals and other components	48
3.3.3	Requirements to the measuring point	48
3.3.4	Fitting in the pipeline	49
3.3.4.1	Installation configurations	51
3.3.4.2	Fitting the FLOWSIC600-XT in the pipeline	60
3.3.5	Signal Processing Unit alignment	62

3.4	Electrical installation	63
3.4.1	Requirements for use in potentially explosive atmospheres	63
3.4.2	General connection of the FLOWSIC600-XT	67
3.4.3	Criteria for electrical connection	68
3.4.4	Electrical connections	68
3.4.5	Available input/output configurations	71
3.4.6	Cable specifications	72
3.4.7	Checking the cable loops	73
3.4.8	Connection parameters of inputs and outputs	74
3.4.8.1	Safety-relevant parameters Ex-i	74
3.4.8.2	Connection parameters Ex-d and Ex-e	75
3.4.8.3	Ex-d terminal compartment	76
3.4.8.4	Ex-e terminal compartment	78
3.4.8.5	Ex-i terminal compartment	80
3.4.9	Connecting the optional backup battery	80
3.4.10	Connecting external pressure and temperature sensors to the electronics	81
4	Commissioning and operation	83
4.1	General information	84
4.2	Parameter display on the display	85
4.2.1	Opening the display protective flap	85
4.2.2	Display and operating elements	86
4.2.3	Display in the symbol bar	86
4.2.4	Configurable standard display	87
4.2.5	Menu structure	89
4.3	Commissioning with the FLOWgate™ operating software	90
4.3.1	Connecting to the device	90
4.3.2	Field setup wizard	91
4.3.2.1	Device identification	91
4.3.2.2	System/User	92
4.3.2.3	I/O configuration	93
4.3.2.4	P + T pressure and temperature sensor	94
4.3.2.5	Volume converters (optional, only for devices with the volume conversion device option)	94
4.3.2.6	Archives/Logbooks	94
4.3.2.7	Diagnostics/warnings	94
4.3.2.8	Meter installation	95
4.3.2.9	Completion	95
4.4	Function check after commissioning	95
4.4.1	Recommended checks:	95
4.4.2	Checking the signal acceptance rate	96
4.4.3	Zero phase check	96
4.4.4	Checking the speed of sound	97
4.4.5	Path failure compensation	98
4.5	Sealing	98

5	Maintenance	99
5.1	General information	100
5.2	Routine checks	100
5.2.1	Checking the meter state	100
5.2.1.1	Function check on the display	100
5.2.1.2	Function check with FLOWgate™	101
5.2.2	Comparing theoretical and measured sound velocity (SOS)	102
5.2.3	Time synchronization	104
5.2.3.1	Time synchronization via Modbus	104
5.2.3.2	Time synchronization with the FLOWgate™ operating software	104
5.2.3.3	Service life/capacity of RTC battery	104
5.2.4	Maintenance report	105
5.2.5	Optional data backup	106
5.2.5.1	Logbook check and data backup	106
5.2.5.2	Checking the data archives (data logs)	107
5.2.6	Creating and evaluating the Diagnostics Comparison report	107
5.3	Exchanging the battery	109
5.3.1	Battery types	109
5.3.2	Information on handling lithium batteries	109
5.3.2.1	Information on storage and transport	109
5.3.2.2	Disposal information	109
5.3.3	Replacing the backup battery	111
5.3.3.1	Swivel the display unit downwards	111
5.3.3.2	Remove the backup battery	112
5.3.3.3	Insert the new backup battery	112
5.3.3.4	Swivel the display unit upwards and lock	113
5.3.4	Replacing the RTC battery	113
5.4	Cleaning the FLOWSIC600-XT	115
6	Shutting down	117
6.1	Returning	118
6.1.1	Contact	118
6.1.2	Packing	118
6.2	Disposal information	118
6.2.1	Materials	118
6.2.2	Disposal	118
7	Troubleshooting	119
7.1	Status messages	120
7.2	Starting a diagnostic session	121
8	Specifications	123
8.1	Conformities	124
8.1.1	CE certificate	124
8.1.2	Standards compatibility and type approval	124
8.1.3	WELMEC conformity	124
8.2	Technical data	125
8.3	Design pressure and design temperature	128
8.4	Measuring ranges	129

8.5	Dimensions	131
9	Annex	137
9.1	Connection diagrams for operation of the FLOWSIC600-XT in accordance with ATEX/IECEX	138
9.2	Connection diagrams for operation of the FLOWSIC600-XT in accordance with CSA	147
9.3	Wiring examples	156
9.3.1	Ex-d (flameproof enclosure)	156
9.3.2	Ex-e (increased type of protection)	160
9.3.3	Ex-i (intrinsically safe)	164
9.4	Power input of the possible input and output configurations	166
9.5	Type plates (examples)	167
9.6	Model name	169
9.7	Spare parts	170

FLOWSIC600-XT

1 Important information

About this document
Important safety information
Intended use
Responsibility of user

1.1 **About this document**

These Operating Instructions describe the FLOWSIC600-XT measuring system. They provide general information on the measuring method employed, design and function of the entire system and its components, as well as on installation, commissioning, maintenance and troubleshooting.

These Operating Instructions cover standard applications which conform with the technical data specified. Additional information and assistance for special applications are available from your Endress+Hauser representative. It is generally recommended to take advantage of qualified consulting services provided by Endress+Hauser experts for your specific application.

1.2 **Important safety information**

1.2.1 **Hazards due to hot, corrosive and explosive gases, or high pressure**

The FLOWSIC600-XT is fitted directly in the gas-carrying line.

The plant operator is responsible for safe operation and for complying with additional national and company-specific regulations.

	<p>WARNING: Hazards through the gas in the system</p> <p>The following conditions can increase the risk:</p> <ul style="list-style-type: none">● Toxic gas or gas dangerous to health● Chemically aggressive gas● Explosive gas● High gas pressure● High gas temperature <p>▶ In installations with an increased risk, the FLOWSIC600-XT may only be fitted and removed when the line is vented or when the installation is at a standstill.</p> <p>▶ The same applies to repair and service work which involves opening the measuring duct or the explosion-proof Signal Processing Unit.</p> <p>Otherwise health or injury risks can possibly arise through escaping gas (e.g. poisoning, burns).</p>
---	--

	<p>WARNING: Hazards through leaks</p> <p>Operation in leaky condition is not allowed and potentially dangerous.</p> <p>▶ Regularly check leak tightness of equipment.</p>
---	--

1.2.2 **Hazard through heavy loads**

The FLOWSIC600-XT measuring system must be attached securely to the carrying structure when being transported and installed.

- ▶ Only use lifting gear and equipment (e.g. lifting straps) suitable for the weight to be lifted. Maximum load information can be found on the type plate of the lifting gear.

	<p>NOTICE:</p> <p>The lifting lugs are designed for transporting the meter only. Do not lift or transport the FLOWSIC600-XT with additional loads using these lugs.</p>
---	--

1.2.3 **Hazard through electromagnetic interference**

	<p>NOTICE: Measuring system FLOWSIC600-XT is a Group 1, Class A device in accordance with EN55011:2009. It is intended for operation in an industrial environment. In other environments, especially in living areas, it could possibly be difficult to ensure electromagnetic compatibility due to the occurring conducted as well as radiated interferences. In this case, the plant operator may be required to take appropriate measures.</p>
---	---

1.3 **Intended use**

1.3.1 **Product identification**

Product name:	FLOWSIC600-XT
Manufacturer:	Endress+Hauser SICK GmbH+Co. KG Bergener Ring 27 01458 Ottendorf-Okrilla Germany

See the main type plate on the Signal Processing Unit for information for the identification of your FLOWSIC600-XT.

Model name

The model names on the type plates identify the various device versions:

Fig. 1

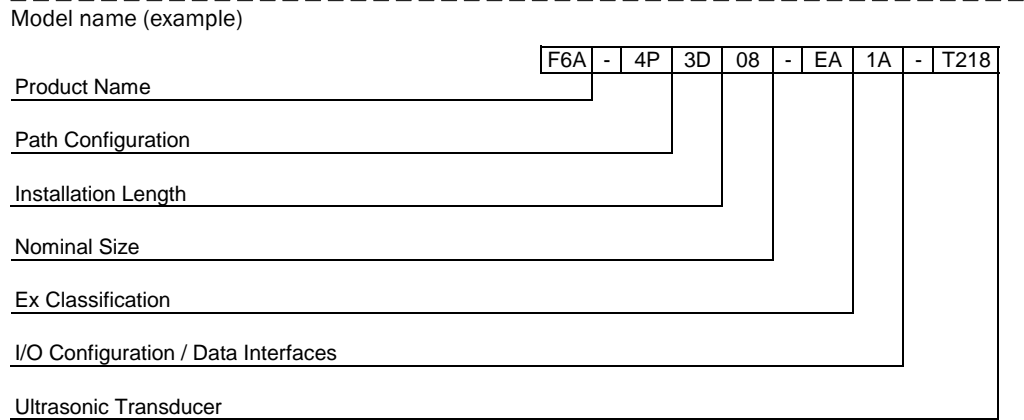

► Detailed description of the model name, see → p. 169, §9.6.

1.3.2 **Purpose of the device**

The FLOWSIC600-XT measuring system is used for measuring the actual volumetric flow rate of gases transported in pipelines. Apart from that, the FLOWSIC600-XT can also determine the actual corrected volume and the sound velocity. Separate meters are available to determine the gas volume depending on the flow direction.

1.3.3 Operation in potentially explosive atmospheres

The FLOWSIC600-XT is suitable for use in potentially explosive atmospheres:

IECEX

Ex db ia op is [ia Ga] IIA /IIC T4 Gb

Ex db eb ia op is [ia Ga] IIA/IIC T4 Gb

Ex ia op is IIA/IIC T4 Ga

ATEX

II 2 (1) G Ex db ia op is [ia Ga] IIA /IIC T4 Gb

II 2 (1) G Ex db eb ia op is [ia Ga] IIA/IIC T4 Gb

II 1G Ex ia op is IIA/IIC T4 Ga

NEC/CEC (US/CA)

Explosion-proof/non-flammable:

Cl I, Div. 1 Group D, T4 / Ex db ia [ia Ga] IIA T4 Gb / Cl I, Zone 1 AEx db ia op is [ia Ga] IIA T4 Gb

Cl I, Div. 1 Groups B, C, D, T4 / Ex db ia [ia Ga] IIC T4 Gb / Cl I, Zone 1 AEx db ia op is [ia Ga] IIC T4 Gb

Intrinsically safe:

Cl I, Div. 1 Group D T4 / Ex ia IIA T4 Ga / Cl I, Zone 0, AEx ia op is IIA T4 Ga

Cl I, Div. 1 Groups A, B, C, D, T4 / Ex ia IIC T4 Ga / Cl I, Zone 0, AEx ia op is IIC T4 Ga

Specific conditions of use (denoted by X after the certificate number)

Valid for IECEX, ATEX, CSA:

- Under certain extreme circumstances, the non-metallic parts incorporated in the enclosure of this equipment may generate an ignition-capable level of electrostatic charge.
Therefore the equipment shall not be installed in a location where the external conditions are conducive to the build-up of electrostatic charge on such surfaces. In addition, the equipment shall only be cleaned with a damp cloth. This is particularly important when installed in a zone 0 location (respectively IIC). (See clause 7.4.2 of IEC 60079-0 / EN IEC 60079-0 / CSA/UL 60079-0)
- The enclosure may be made from low copper aluminium alloy. In rare cases, ignition sources due to impact and friction sparks could occur. The user must ensure that the enclosure is suitably protected against danger from impact or friction, particularly when installed in a zone 0 location.
(See clause 8.3 of IEC 60079-0 / EN IEC 60079-0 / CSA/UL 60079-0)
- The ultrasonic sensors are manufactured from titanium. The pipeline adaptor and part of the electronic enclosure may be made from aluminium. In rare cases, ignition sources due to impact and friction sparks could occur. The user must ensure that the ultrasonic sensors are suitably protected against danger from impact or friction.
(See clause 8.3 of IEC 60079-0 / EN IEC 60079-0 / CSA/UL 60079-0)
- The maximum piezo-electric energy released by impact on the ultrasonic sensors exceeds the limits specified in Clause 10.7 of IEC 60079-11:2011 / EN 60079-11:2012 / CSA/UL 60079-11:2011.
The user must ensure that the ultrasonic sensors are suitably protected against danger from impact.

- The apparatus is not capable of withstanding the 500 V insulation test required by clause 6.3.13 IEC 60079-11:2011 / EN 60079-11:2012 / CSA/UL 60079-11:2011 (Except at the optically isolated inputs/outputs). See the installation instructions regarding the correct electrical installation.



NOTICE:

See → p. 63, §3.4 and → p. 138, §9.1 “Connection diagrams for operation of the FLOWSIC600-XT in accordance with ATEX/IECEX” or → p. 147, §9.2 “Connection diagrams for operation of the FLOWSIC600-XT in accordance with CSA” for correct electrical installation.

- Contact the manufacturer if dimensional information of flameproof joints is needed. (See clause 5.1 of IEC 60079-1 / EN 60079-1 CSA/UL 60079-1)
- The replaceable backup battery pack and connecting circuit have been assessed for intrinsic safety in accordance with IEC 60079-11:2011 / EN 60079-11:2012 / CSA/UL 60079-11:2011, and is acceptable for use in the non-intrinsically safe versions of the equipment.
- When 3/4 NPT entries are provided, entry devices shall be installed with five fully engaged threads, tightened with a minimum torque of 90 Nm (800 in-lbs).

Additionally valid for IECEX, ATEX:

- The equipment contains a shunt Zener diode barrier, which requires connection to a barrier earth in accordance with IEC 60079-14 / EN 60079-14.
- Ambient temperature range and process temperature range: See thermal parameters, Technical Data, → p. 125, §8.2.

1.3.4 **Operation in pressure applications**

Design, manufacture and inspection of the FLOWSIC600-XT are performed in accordance with the safety requirements in the European Directive 2014/68/EC for pressure equipment.

1.3.5 **Restrictions of use**

Check the FLOWSIC600-XT is suitably equipped for your application (e.g., gas conditions).



NOTICE:

► The plant operator must ensure that the upper/lower limit values shown on the type plate are not overflowed or underflowed in operation.

The measuring system must only be used as specified by the manufacturer and as set forth below. Pay special attention that the equipment complies with the technical data, information about the permitted use as well as assembly, installation, ambient and operating conditions.

Relevant information is provided in the order documentation, type plate, certification documents and these Operating Instructions.

1.4 Responsibility of user

- ▶ Only put the FLOWSIC600-XT into operation after reading the Operating Instructions.
- ▶ Observe all safety information.
- ▶ If anything is not clear: Please contact Endress+Hauser Customer Service.

1.4.1 Designated users

These Operating Instructions are intended for skilled persons familiar with the following tasks:

- Installation (setting up/assembly)
- Commissioning
- Handling and monitoring during operation
- Maintenance/service.

**NOTICE:**

Skilled persons are persons in accordance with DIN VDE 0105 or IEC 364, or directly comparable standards. It is decisive that these persons can recognize and avoid possible hazards, especially hazards arising from gases dangerous to health, and hot or pressurized gases.

- Installation, commissioning, maintenance and inspection may only be carried out by skilled persons having knowledge of the relevant rules and regulations for potentially explosive atmospheres, especially:
 - Ignition protection types
 - Installation regulations
 - Zone classification

1.4.2

Correct use

- ▶ Only use the FLOWSIC600-XT as described in these Operating Instructions. The manufacturer bears no responsibility for any other use.
- ▶ Do not carry out any work or repairs on the FLOWSIC600-XT not described in these Operating Instructions.
- ▶ Do not remove, add or change any components in or on the FLOWSIC600-XT unless such changes are officially allowed and specified by the manufacturer. Otherwise:
 - Any warranty by the manufacturer becomes void
 - The FLOWSIC600-XT can become dangerous
 - The approval for use in potentially explosive atmospheres is no longer valid
 - The approval for use in lines pressurized above 0.5 bar (7.25 psi) bar is no longer valid.

1.4.3

Danger identification on device

The following symbol draws attention to important hazards directly on the device:



- ▶ Consult the Operating Instructions in all cases where the symbol is attached to the device or shown on the display.

1.4.4

Special local conditions

- ▶ Follow all local laws, regulations and company-internal operating directives applicable at the installation location.

1.4.5

Retention of documents

- ▶ Keep these Operating Instructions available for reference.
- ▶ Pass these Operating Instructions on to a new owner.

FLOWSIC600-XT

2 Product description

- System components
- Measuring principle
- Correction of the effect of pressure and temperature on the geometry of the meter body
- Features and applications
- Operating software FLOWgate™
- Operating modes, meter states and signal output
- Interfaces
- Totalizers
- Diagnostics function i-diagnostics™
- Data processing in FLOWsIC600-XT
- Sealing
- PowerIn Technology™

2.1 System components

The FLOWSIC600-XT measuring system consists of the following hardware components:

Fig. 2 Overview FLOWSIC600-XT

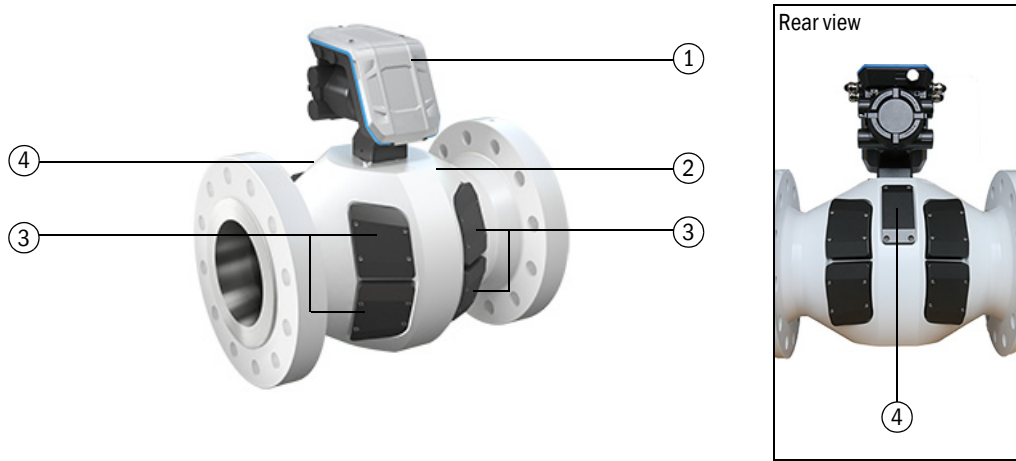

- 1 Signal Processing Unit
- 2 Meter body
- 3 Cover caps for ultrasonic transducers
- 4 Cover cap for integrated pressure and temperature sensor

Fig. 3 Overview FLOWSIC600-XT C

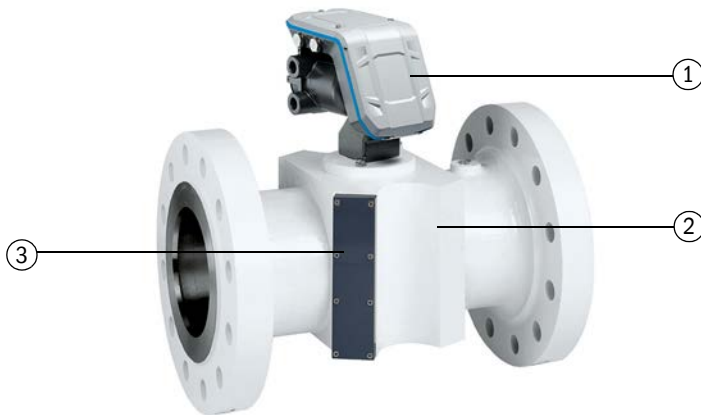

- 1 Signal Processing Unit
- 2 Meter body
- 3 Cover cap for ultrasonic transducers

2.1.1 Meter body

The meter body consists of a mid section for mounting the ultrasonic transducers, with flanges on either end. The meter body is made of a single-piece forging, which is machined on precision equipment to ensure high reproducibility of the geometric parameters.

The internal diameter, design of the sealing surface, and standard dimensions of the flanges are in accordance with the specifications in the data sheet and key code. The meter body material is chosen to suit customer requirements. Standard meter bodies are available in carbon steel, low temperature carbon steel and stainless steel.

The meter bodies can be delivered in several nominal sizes (→ p. 131, §8.5).

2.1.2 **Ultrasonic transducers**

Ultrasonic transducers optimally tuned to system requirements are fitted on the FLOWSIC600-XT. The high quality of the transducer design provides the basis for accurate and highly stable transit time measurement of the ultrasonic signals with nanosecond precision.

In order to meet as many application requirements as possible, an ultrasonic transducer suitable for this application is used depending on process parameters gas pressure and temperature, noise and gas composition. The basis for this is a sensor portfolio approved within the framework of the EU Type Examination Certificate.

In principle, the installed ultrasonic transducers are already functional at ambient pressure, which brings numerous advantages. Some selected transducer types, especially for applications above 105 bar absolute pressure, are optimized for high pressure use to ensure the measuring function. A minimum pressure of ≥ 5 bar(a) is usually required for these sensor types.

2.1.3 **Signal Processing Unit**

The Signal Processing Unit contains all the electrical and electronic components for controlling the ultrasonic transducers. It generates transmission signals and analyzes the received signals to calculate the measured values. The Signal Processing Unit also contains several interfaces for communication with a PC or standardized process control system.

The meter counters, log books (errors, warnings, parameter changes) and data logs are stored with a timestamp in a 30 second time grid, → p. 38, §2.10.1.

On system restart, the meter levels that were last saved are restored as the start values for the volume counters.

The Signal Processing Unit has a three-line LCD display for the current measured data and diagnostics data. Selection is possibly by operation with pushbuttons on the display. Configuration is not possible on the display, but only via the FLOWgate™ operating software.

The connection terminals for power supply and the I/O interfaces for communication with the device are located in a separate terminal compartment of the Signal Processing Unit.

2.1.4 **Integrated pressure and temperature sensor**

As an option, the FLOWSIC600-XT has an integrated pressure and temperature sensor. This sensor measures the process parameters gas pressure and gas temperature at the same time.

The values measured for pressure and temperature are used to correct the meter body geometry and to determine the current Reynolds number.

The sensor is not subject to (re-)calibration intervals. Its measurement uncertainty is 1% over the entire measuring range and is therefore sufficiently accurate for the geometry and Reynolds number correction in electronics.

The integrated pressure and temperature sensor cannot be used for volume conversion.

2.2 **Measuring principle**

The FLOWSIC600-XT measuring system works according to the principle of ultrasonic transit time difference measurement. This allows conclusions to be made on the gas volume flowing through based on the sound velocity transfer time. Measurement is carried out in a direct path layout to keep disturbing effects such as gas flow turbulence, dirt, moisture or interfering noises as low as possible. Two ultrasonic transducers are positioned opposite each other in a defined angle to the gas flow and operate alternately as sender and receiver.

Fig. 4 Measuring principle

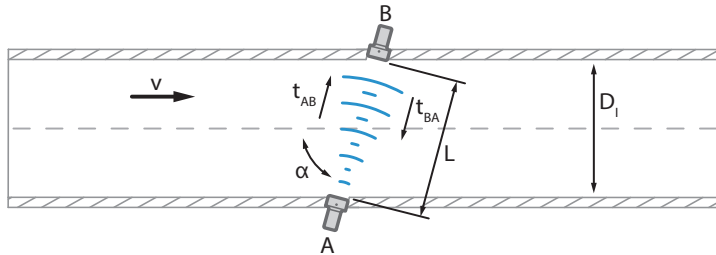

- A + B = Ultrasonic transducers
- v = Gas velocity
- L = Path length
- α = Path angle in °
- t_{AB} = Transit time of signal in flow direction
- t_{BA} = Transit time of signal against flow direction
- D_i = Pipe inner diameter

2.2.1 **Determination of gas velocity**

The FLOWSIC600-XT determines the gas velocity on each measuring path 10 times per second as standard. The following calculations are carried out to determine the gas volume.

2.2.1.1 **Determination of transit time of ultrasonic signals**

Signal transit time in flow direction

$$t_{AB} = \frac{L}{c + v \cdot \cos \alpha}$$

Signal transit time against flow direction

$$t_{BA} = \frac{L}{c - v \cdot \cos \alpha}$$

2.2.1.2 **Determination of path velocity**

The path velocity (v_{path i}) is calculated from the difference between the two transit times:

$$v_{path\ i} = \frac{L_i}{2 \cdot \cos \alpha} \cdot \left(\frac{1}{t_{AB\ i}} - \frac{1}{t_{BA\ i}} \right)$$

2.2.1.3 **Determination of flow rate**

The sum of the weighted average of each of the n path velocities is the flow velocity through the meter body.

$$v_A = w_i \sum_{i=1}^n v_{path\ i}$$

2.2.1.4 **Determination of volumetric flow a. c.**

The uncorrected volumetric flow Q_b^* is calculated from the flow velocity v_A and the open cross-sectional area in the measuring section of the meter body:

$$Q_b^* = v_A \cdot \frac{D^2 \cdot \pi}{4}$$

The linearization via the Reynolds number (K_{Re}) and the correction of the non-ideal velocity distribution in the flow profile ($K_{profile}$) also affect this result. This is taken into account using correction coefficients.

$$Q_b = Q_b^* \cdot K_{Re} \cdot K_{profile}$$

2.3 **Correction of the effect of pressure and temperature on the geometry of the meter body**

The influence of process pressure and temperature on the geometric parameters of the meter body can be compensated for by the gas meter. In addition to the compensation required by ISO 17089-1:2019, the influence on the ultrasonic transducers is also compensated in order to determine the exact actual flow volume ($Q_{v, corr, a.c.}$).

2.3.1 **Correction in FLOWSIC600-XT electronics**

The gas meter compensates for the influence of pressure and temperature on the path length between the ultrasonic transducers and the diameter of the measuring section by linear scaling using the material-specific parameters in registers #7422 ... #7432.

The signal transit times are used to calculate the path velocity with the compensated path lengths. The average flow rate is calculated as the weighted sum of the individual path velocities.

The uncorrected flow rate is derived taking into account the pressure- and temperature-compensated diameter of the measuring section (register #7416). This value is linearized with a function dependent on the Reynolds number as part of the calibration. The flow volume is displayed in register #9388.

Finally, this linearized and adjusted flow value is calculated back to an average flow value, taking into account the inner diameter (register #7418).

The current gas velocity can be read in register #9390.

- Register number 7068 ... 7086 Path length
- Register number 7088 ... 7106 Path angle
- Register number 7416 Measuring section diameter
- Register number 7418 Pipe diameter

Endress+Hauser recommends leaving this meter body correction in the device.

2.3.2 **Correction outside the FLOWSIC600-XT electronics (flow computer)**

If the meter body diameter is to be corrected in a connected flow computer, it is important to adjust the device-internal correction accordingly.

- 1 The inner diameter of the measuring section of the meter body (register #7418) must be stored in the flow computer as the reference diameter.
- 2 The influence of pressure and temperature on the reference diameter is corrected against the calibration conditions with the specific constants α_T and α_p . Here, ΔT and Δp are the respective differences between the actual process values and the calibration.

$$dia_{corr} = dia \cdot (1 + \alpha_T \cdot \Delta T + \alpha_p \cdot \Delta p)$$

- 3 Using the average gas velocity VOG (register #9390) and the corrected diameter, the current flow rate is calculated as follows.

$$Q_{v,corr} = \frac{\pi}{4} \cdot dia_{corr}^2 \cdot VOG \cdot 3600$$

- $Q_{v, corr}$ = Current flow rate in m³/h
- VOG = Average gas velocity in m/s
- dia_{corr} = Compensated diameter in m
- α_T = Material-specific coefficient of expansion for the temperature
- α_p = Linear expansion coefficient for the pressure (calculated from the thick-walled cylindrical pipe model (Roark's formulas for stress and strain))

$$\alpha_p = \left(\frac{R_o^2 + R_i^2}{R_o^2 - R_i^2} + \mu \right) \cdot \frac{1}{E}$$

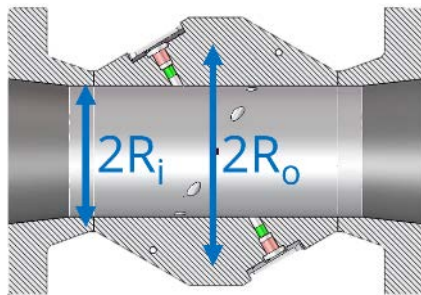

- ΔT = Difference between operating temperature and calibration temperature in K
- Δp = Difference between operating pressure and calibration pressure in MPa
- R_o = Outside radius
- R_i = Inside radius
- μ = Poisson's ratio
- E = Young module
- t = Wall thickness of the meter body to be taken into account in the measuring section; t depends on the transducer type, see Table 1

Table 1 Transducer types and wall thickness

Transducer type	Wall thickness t
26, S5, S6, T210, H210, T240	30 mm
16, 46, K4, S4	39 mm
15, 18, 22, 28, B7, K3, L8, S2, S7, S8, S9, T8, T218, H218	52 mm

2.4 **Features and applications**

2.4.1 **FLWSIC600-XT**

The FLWSIC600-XT is the all-round device for all natural gas applications subject to custody transfer.

The FLWSIC600-XT is equipped with four ultrasonic measuring paths and measuring electronics (transducer/Signal Processing Unit). Meters with 4 paths can be used for fiscal gas metering in any segment of the natural gas market, including extraction, transportation, distribution and storage. National Type Examination Certificates exist for several countries.

Fig. 5 FLWSIC600-XT



2.4.2 **FLWSIC600-XT 2plex**

The FLWSIC600-XT 2plex is a very compact combination of a gas flow meter for custody transfer with a control measuring device, and provides advanced diagnostics functionality with an additional independent measuring path.

With their different path arrangements and the resulting difference in sensitivity, the diagnostics systems of the FLWSIC600-XT 2plex can be compared in order to identify disturbances (caused by contamination, pulsation or noise) at an early stage and provide a warning.

Fig. 6 FLWSIC600-XT 2plex



2.4.3 FLOWSIC600-XT Quatro

The FLOWSIC600-XT Quatro combines two redundant measuring devices in one for redundant measurements in natural gas applications subject to custody transfer.

Additionally, should one of the electronics develop a problem or fail, the secondary unit will continue to provide accurate measurement data.

Fig. 7 FLOWSIC600-XT Quatro

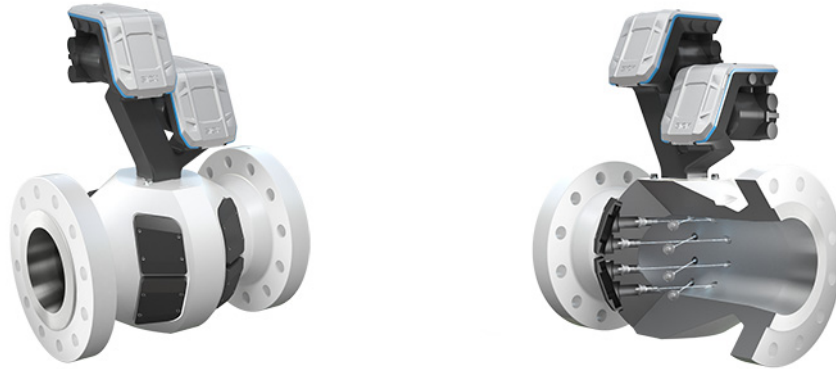

2.4.4 FLOWSIC600-XT Forte

The FLOWSIC600-XT Forte provides eight paths on two different path levels and is especially suitable for installation in systems with short inlet and outlet sections.

Fig. 8 FLOWSIC600-XT Forte



2.4.5 **FLWSIC600-XT C**

The FLWSIC600-XT C is a 4-path meter for all gas applications subject to custody transfer similar to the FLWSIC600-XT, but with a different meter body shape. Optional functions such as the integrated pressure/temperature sensor or i-diagnostics™ are not available.

Fig. 9 FLWSIC600-XT C



2.4.6 **FLWSIC600-XT (non-custody transfer version)**

The FLWSIC600-XT is also available as a 2-path meter for non-custody transfer applications. 2-path meters are mainly used for process control and internal billing.

Fig. 10 FLWSIC600-XT (non-custody transfer version, 2-path)



2.4.7 **FLWSIC600-XT Gateway**

The FLWSIC600-XT Gateway is an upgrade kit for the FLWSIC600 gas flow meter. 4-path devices as well as 2-plex (4+1) and Quattro (4+4) devices can be equipped with a new electronics unit. The conversion can be carried out in the field as well as on a test bench or in the Endress+Hauser factory. The device configuration from the existing FLWSIC600 is used. The process is supported by the firmware update assistant in FLOWgate™.

The FLWSIC600-XT Gateway enables a resource-saving service life extension of the measuring device. An existing FLWSIC600 is technically upgraded to the status of the FLWSIC600-XT.

The Gateway type plate, which differs from the FLWSIC600-XT, is shown as an example in → p. 167, §9.5.

Fig. 11 FLOWSIC600-XT Gateway



2.5 Operating software FLOWgate™

The FLOWgate™ operating software allows user-friendly access to all measured values of the device.



For information on FLOWgate™ operating software, see “Software Manual FLOWgate™”.

The Software Manual is on the or the product web site.

The Software Manual is also available using the Help function of the FLOWgate™ operating software.

2.5.1 Overview

Software functions

- Measured values overview
- Diagnostics data
- Logbook and archive management
- Commissioning
- Parameter modification
- Session browser
- Calibration

Fig. 12 Overview FLOWgate™ Operating Software

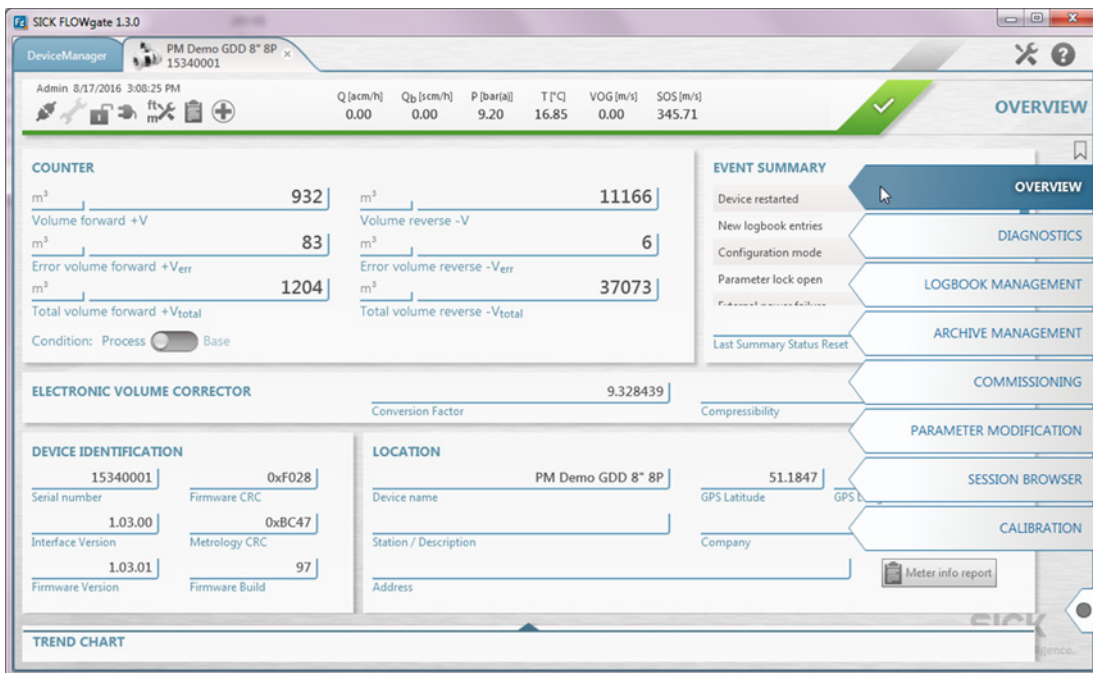

2.5.2 System requirements

- Microsoft Windows XP/7/8/10
- Min. 1 GHz CPU
- Min. 512 MB RAM
- Approx. 1 GB free memory (without .NET framework)
- USB or serial interface
- Recommended minimum screen resolution: 1024 x 768 pixels, optimum screen resolution 1368 x 768 pixels
- Microsoft .NET framework 4.0

2.5.3 Access rights

The FLOWSIC600-XT provides not only various access levels but also allows several single users per access level. Only one user can be logged onto the device at any one time. Three different users with the same access rights are possible for access levels “User” and “Authorized user”.

Users with access level “User”, “Authorized user” or “Admin” can create an individual user name and an individual password.

Users can be managed by “Admin” or Endress+Hauser Service.

The following functions are available depending on the active access level:

Table 2

Access rights

Device function	Guest	User	Auth. user	Admin
Standard password		1111	2222	3333
Overview	X	X	X	X
Read parameters and measured values	-	X	X	X
Read archives	-	X	X	X
Change parameters not custody relevant	-	-	X	X
Change custody relevant parameters	-	-	X	X
Air test mode	-	-	X	X
Configuration mode	-	-	X	X
IO test	-	-	X	X
Regional device adaptation	-	-	X	X
User management	-	-	-	X



The device-specific administrator password can be found in the delivery documentation (Parameter report p. 2 “User password”).

2.6 **Operating modes, meter states and signal output**

The FLOWSIC600-XT has the following operating modes:

- Measuring mode
- Air test mode
- Configuration mode

If necessary, the pulse valency must be changed when using Air test mode.

2.6.1 **Measuring mode**

The FLOWSIC600-XT can have the following status during measuring mode:

- Measurement valid
- Measurement invalid
- Maintenance request

In measuring mode, the FLOWSIC600-XT operates in one of three meter statuses depending on the measuring conditions.

2.6.2 **Air test mode**

Air test mode serves to carry out a test bench calibration with the test medium air at ambient pressure. Entries are made in the Event logbook when air test mode is activated and deactivated. The measurement is marked as invalid in air test mode.

2.6.3 **Configuration mode**

Configuration mode serves to protect against unintentional or unallowed parameter changes. Therefore configuration mode must be activated for most configuration handling or parameter changes. Changing parameters for certain modules (e.g. serial interface) is first active after configuration mode is deactivated. The measurement is marked as invalid when configuration mode is activated when the parameter locking switch is open.

2.7 Interfaces

Further devices (e.g. volume converters, measured value remote transfer units) can be connected to the FLOWSIC600-XT via the available interfaces. The interfaces accessible in the terminal compartment are non-reactive. Available input/output configurations, see → p. 71, §3.4.5.

2.7.1 Analog outputs

The FLOWSIC600-XT has an optional 4-20 mA analog output to output the various measured values. The resolution of the output is 16 bit with an update rate of 8 Hz. The accuracy of the analog output is $\leq 0.1 \dots 0.2\%$.

The behavior of the analog output for bidirectional operation can be selected in register # 4021. By default, the negative flow rate (reverse direction) is output as a negative value (linear behavior). When switching to bidirectional operation, an absolute value is always output, independent of the flow direction.

It is recommended to check and, if necessary, adjust the analog output during commissioning.

2.7.2 Digital outputs

The FLOWSIC600-XT has 4 digital outputs (FO.0, FO.1, DO.2 and DO.3) to output the impulses proportional to the flow rate and status information. The digital outputs are electrically isolated with a synchronous refresh in a configurable period between 0.1 to 1 s. The refresh rate can be configured.

Status output

All the digital outputs can be configured individually to output various status information.

The following output modes are available:

- Inactive
The output remains at its set idle level. This setting is especially useful for low power applications when the output is not used.
- Measurement valid
The output is only activated when the measurement is valid. The output is deactivated when a device error occurs (system error or air test mode), or when maintenance mode is active when the parameter locking switch is open.
- Error
The output is activated when a device error is present (system error or air test mode).
- Maintenance request
Maintenance request is reported and the output activated when measuring precision can be impaired when a component fails or is configured incorrectly.
- User warning
The output is activated when a user limit is exceeded.
- Configuration mode
The output is activated when the device is in configuration mode.
- Reverse flow
The output is activated when the flow direction through the device is negative (reverse flow).

Pulse output

An adjustable measured value can be output on the two pulse outputs FO.0 (DO.0) and FO.1 (DO.1) proportional to the frequency. The maximum adjustable frequency is 10 kHz.

The following can be set as output value via the associated configuration register:

- Operational flow rate
- Base flow rate

Setting the status and pulse outputs

Following options can be set:

- 2x status
The outputs operate as status outputs and are set via the corresponding configuration registers.
- Pulse output and status output
Direction-independent pulses are output on FO.0. FO.1 operates as status output and is set via its configuration register.
- 2x pulse output
Direction-independent pulses are output on FO.0 and FO.1.
- Phase offset 90°
FO.0 and FO.1 output a signal with a phase offset of 90°. FO.0 leads for positive values and follows for negative values.

Fig. 13

Phase offset 90°

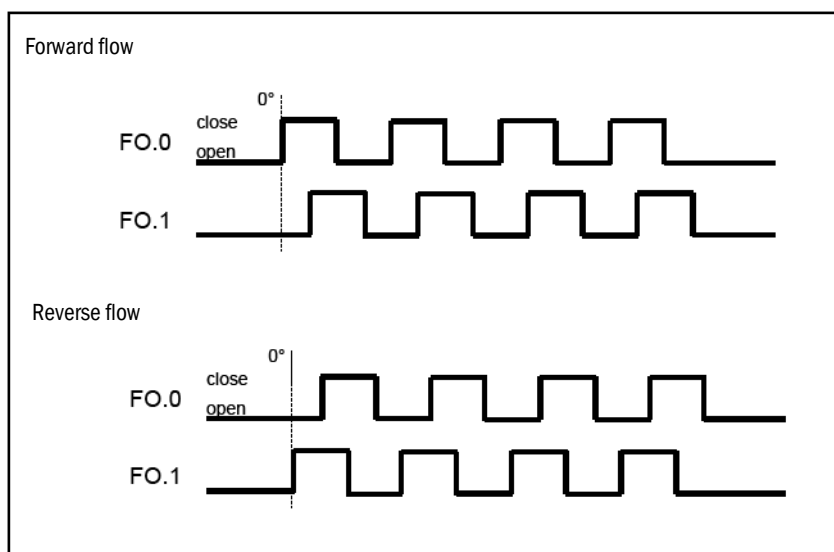

- Separate direction outputs
For forward flow, pulses are output on FO.0. FO.1 is inactive. For backward flow, pulses are output on FO.1. FO.0 is inactive.

Fig. 14 Separate direction outputs

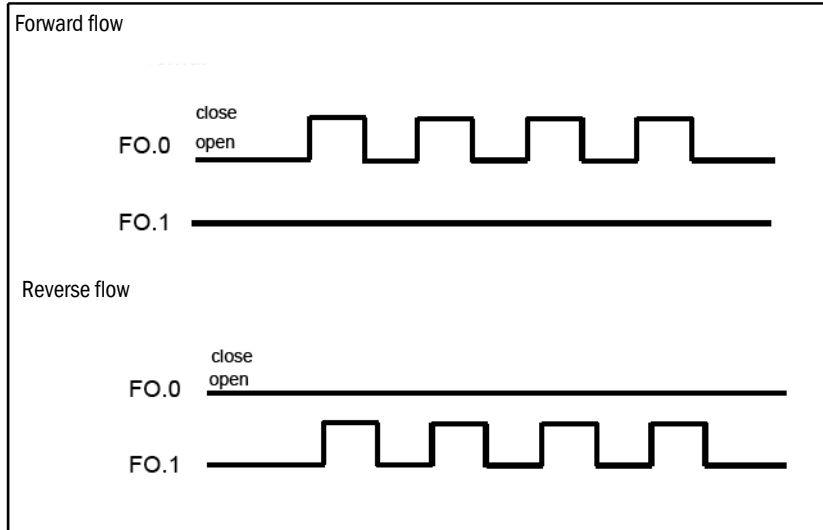

- Inverted with error signaling
Direction-independent pulses are output on FO.0. FO.1 outputs an inverted signal to FO.0 and is retained inactive in state "Measurement invalid".

Fig. 15 Inverted with error signaling

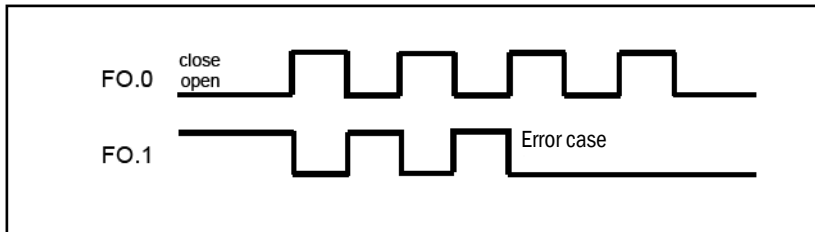

NOTICE:
 The measurement is marked as invalid when the FLOW SIC600-XT is in Configuration mode with open calibration switch. The device goes into "Error" mode.
 The representation of this behavior via the pulse output is done by selecting "Inverted with error signaling".

2.7.3 Encoder totalizer

(Digital interface for primary devices with meter reading transmission according to DVGW Information GAS No. 23, December 2017)
 Alternatively, the meter reading can be transmitted digitally coded (ENCODER) to volume converters and additional devices as a metrologically secured point-to-point connection. Compatibility with the downstream device is ensured when this device runs with the same interface protocol. It is recommended to check this during an operating point test.

2.7.4 **Serial data interfaces**

- RS-485 (3x, for configuration, measured value output and diagnostics)
 MODBUS ASCII, MODBUS RTU;
 The configuration of the RS485.1 interface at the factory is configured uniform to support smooth calibration of the device.
 Configuration:
 - Protocol type: MODBUS-RTU
 - Modbus configuration: FL600XT (standard)
 - Baud rate: 38,400 baud
 - Bit protocol: 8N1
- Ethernet (1x optional for configuration, measured value output and diagnostics),
 MODBUS TCP

The serial interfaces can be used as metrological secured point to point connection for connecting volume converters or auxiliary equipment. In this case, the compatibility is defined in the documents of the downstream device.



For further information, see document “8019260 Addendum to Operating Instructions FLOWSIC600-XT: Interfaces”.

2.7.5 **Optical data interface**

The FLOWSIC600-XT has an optical interface compliant with IEC 62056-21 on the front panel with bit-serial, asynchronous data transfer (protocol MODBUS RTU).

A computer can be connected using an infrared/USB adapter (Part No. 6050602).

The interface can be used to read out data and parameter values as well as to configure the device. A firmware update can be carried out using this interface when the parameter locking switch is open.

2.8 **Totalizers**

In addition to the main encoder totalizer, the volumes measured during a malfunction are recorded for each flow direction by a special malfunction volume encoder totalizer. Resetting the malfunction volume encoder totalizer can be traced in the Event logbook of the meter.

The FLOWSIC600-XT is designed bi-directional and has a configurable zero-flow cutoff set to $0.25 Q_{min}$ at the factory.

2.9 **Diagnostics function i-diagnostics™**

i-diagnostics™ is the intelligent combination of firmware and software that means safe, reliable, and easy to use device operation for the entire operating time.

i-diagnostics™ is based on the FLOWSIC600's CBM (Condition Based Maintenance) smart self-diagnostics functionality. In addition to meter diagnostics, it provides useful information about the system status and any changes to it.

In order to assess the application, diagnostics data from cross-eyed beams is first factored in, with application faults, such as blocked flow conditioners, background noise, corrosion or liquids in the gas being detected automatically. Process data is constantly assessed on the basis of the integrated Fingerprint concept.

This means the measurement conditions during calibration can be compared with the measurement conditions during commissioning and with the current measurement and diagnostics data. An internal dialog continuously logs measured values which allow trend

analyses to check the historical measurement process. An internal dialog continuously logs the self-monitoring results so that a retroactive check of the measurement process in the form of a graphic trend analysis is also possible.

2.9.1 Fingerprint System

The FLOWsIC600-XT is equipped with a so-called Fingerprint System, which records process and diagnostic data to examine the current operating state for changes to an operating state in the past. A warning can be generated when changes are detected. In addition, it is possible to obtain complete images of device statuses at different points in time.

The “Fingerprint System” enables an application-specific tightening of monitoring limits and is therefore very well suited for detecting small or creeping changes in process variables. Especially changes of device parameters due to ageing of transducers/electronics and contamination of transducers or flow influencing components (e.g. flow conditioners) can be detected. The “Fingerprint System” is primarily designed to detect long-term relevant deviations.

The “Fingerprint System” has 11 non-volatile stored measured data entries (zero point, five speed classes in forward direction and five speed classes in reverse direction) for each of the three different states:

- Calibration (low pressure or high pressure calibration)
 - For calibration, the Calibration wizard provided in the FLOWgate operating software must be used.
 - Data are recorded by FLOWgate during the calibration, written to the device and read-out as required. At the end of each calibration, FLOWgate prompts whether the data should be saved (and if already existing, overwritten).
 - With the data, the time, measurement conditions and performance during calibration can be traced very well.
 - Has informative character.
- Reference data for field commissioning
 - The reference is initially generated automatically by the device in a teach-in process (after commissioning).
 - The reference can be overwritten by a reference generated by FLOWgate, e.g. from the diagnostic archive.
 - The reference serves as normal for the current condition assessment.
- Current data
 - A user warning is generated when one or more diagnostic variables deviate from the reference data by more than an adjustable limit. All monitoring can be activated individually.
 - Represent a complete current process image.

The data records of the different operating states are divided into different “classes” by the flow velocity. Comparisons between reference data and current data are only made in data records of the same class.

Fig. 16 „Fingerprint System“ example

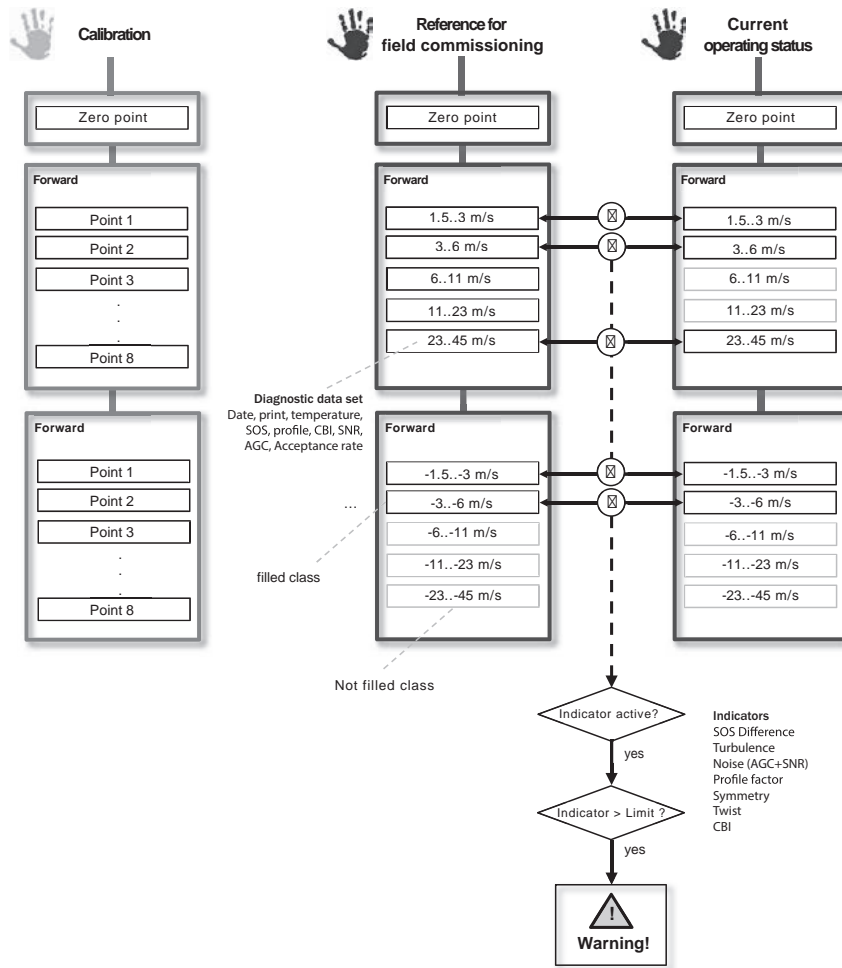

2.10 Data processing in FLOWSIC600-XT

2.10.1 Logbooks

- Event logbook (1,000 entries)

Custody relevant and other events are written to the event logbook. It can store 1000 entries. As standard, no entries are overwritten when the logbook is full. An error message is output.



NOTICE: Type approval

Meter status “Measurement invalid” is activated when the FLOWSIC600-XT is configured as a verifiable meter and the maximum number of entries is reached in the metrology logbook or parameter logbook. Measured volumes are registered in the malfunction volume encoder totalizers.

The event logbook can be reset only when the parameter locking switch is open. Timestamp, meter level, user ID of the active user, the event code and possibly supplementary information are saved.

- Parameter logbook (200 entries)

The parameter logbook saves all parameter changes. It has a capacity of 200 entries and is circulating by default. The oldest entries are deleted when the parameter logbook overflows. Timestamp, meter level, user ID of active user, interface version, old value, new value as well as the Modbus register number are saved.

When an overflowing/rolling logbook is set, the index numbers are further incremented and the oldest entries overwritten with new data entries. Old entries are lost if no regular backup with is made with the FLOWgate™.

- Metrology logbook (50 entries)

Selected calibration-relevant parameters can be modified when the parameter locking switch is closed and after logging in as authorized user.

An entry in the metrology logbook is generated to ensure the traceability of these parameter changes. The following parameters can be changed when the parameter locking switch is closed:

- Pulse valency
- Ambient pressure
- Minimum and maximum measurement pressure
- Default values for pressure and temperature
- Deactivation of Metrology Logbook

Timestamp, meter level, user ID of active user, old value, new value as well as the Modbus register number are saved. The metrology logbook has a capacity of 50 entries and stops by default when it is full. When the metrology logbook is full, changes of custody-relevant parameters can only be carried out when the parameter locking switch is open. The metrology logbook can be reset only when the parameter locking switch is open.

2.10.2

Archives

- One configurable diagnostics archive (6,000 entries)
Diagnostics data are saved in cyclic intervals in the diagnostics archive. The storage period can be set in the range from 15 min to 6 h. Dataset number, timestamp, various global measured values, status information and path information are saved. The archive has a capacity of 6000 entries and is circulating by default. The archive serves primarily for analysis of historical measured data.
- Two configurable archives (6,000 entries each)
Accounting data are saved in cyclic intervals in data archives 1 and 2. The storage period can be set in the range from 15 min to 24 h. Dataset number, timestamp, status information, various meter levels as well as various operating variables and standardized variables are saved. The archives have a memory of 6000 entries and are circulating by default.

Table 3 Data archive contents and structure

Element	Significance
Date record number	Consecutive number of the data record, is not reset when the logbook is cleared.
Timestamp	Time of the entry as Unix timestamp (UTC)
Unit ID	Bits 0 : Pressure type (0=absolute, 1=relative) 1 : Unit system (0=metric, 1=imperial) 2..4 : Pressure unit 5..7 : Temperature unit
Flowtime	Percentage of periods in which the throughflow was in the recording direction [%]
Detail status	Detailed status information (ActualStatus)
Meter 1 : V	Totalizer 1 : Volume uninterrupted/total
Meter 1 : Verr	Totalizer 1 : Volume when meter in malfunction status
Meter 1 : ID	Totalizer 1 : Bits 0 : Totalizer status (0=uninterrupted, 1=total) 1..2 : Totalizer type (0=operation, 1=standard, 2=mass, 3=reserved) 3..6 : Power of ten totalizer resolution plus 8 7 : Unit system (0=metric, 1=imperial)
Meter 2 : V	Totalizer 2 : Volume uninterrupted/total
Meter 2 : Verr	Totalizer 2 : Volume when meter in malfunction status
Meter 2 : ID	Totalizer 2 : Bits 0 : Totalizer status (0=uninterrupted, 1=total) 1..2 : Totalizer type (0=operation, 1=standard, 2=mass, 3=reserved) 3..6 : Power of ten totalizer resolution plus 8 7 : Unit system (0=metric, 1=imperial)
Pressure	Pressure (average ^[1] of the measuring period)
Temperature	Temperature (average ^[1] of the measuring period)
Compressibility	Compressibility (average ^[1] of the measuring period)
Conversion factor	Conversion factor (average ^[1] of the measuring period)
SOS	Sound velocity (average ^[1] of the measuring period)
Molar mass	Molar mass (average ^[1] of the measuring period)
Density	Density (average ^[1] of the measuring period)
Reserved	Field reserved (for future extensions (must be zero!))
Check sum	CRC-16 check sum for the data record

[1]) The values are throughflow-weighted in the recording direction when the throughflow was within the period in recording direction. The values are averaged when no throughflow existed within the period.

2.10.3

Protection of parameters from undesired changes

Three different mechanisms have been integrated as protection of the parameters from undesired changes or manipulation attempts:

- User identification
Users must identify themselves with a user ID and a user password as protection against manipulation attempts. An access level which allows access to certain settings and commands is assigned to every user level.
- Configuration mode
General protection of all (configuration) parameters from undesired changes. Configuration mode can be activated only from access level “Authorized user”.
- Parameter locking switch
The parameter locking switch is a hardware switch in the device and is normally located underneath a calibration seal. The parameter locking switch serves for protection against unauthorized parameter changes. Certain parameters that are protected with the parameter locking switch can also be changed when the parameter locking switch is closed. These changes are possible only when free entries exist in the metrology logbook.

2.11 **Sealing**

The meter has metrological seal positions on the electronics cover, display cover, terminal compartment covers and the transducer cover caps.

Sealing can be done with adhesive labels. Alternatively the terminal compartment covers can be sealed with wire seals.

Sealing of the parameter locking switch

The parameter locking switch and the battery of the real-time clock are protected mechanically by a mutual joint cover. The fixing screw of this cover must be secured by a label positioned approximately equal on the cover and cover plate.

Fig. 17 Sealing of parameter locking switch

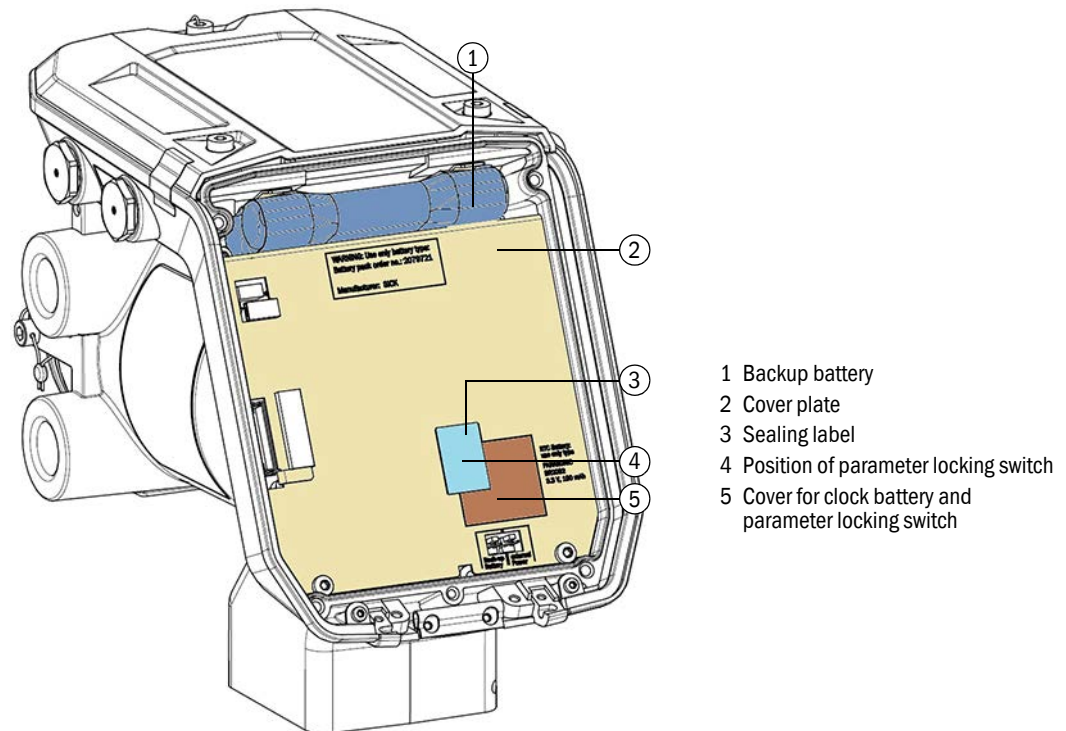

Sealing on the Signal Processing Unit

Metrological sealing of the terminal compartment must be carried out during commissioning according to national regulations.

The protection of the terminal compartment active in use must be carried out according to the chosen explosion-proof model of the interface electronics of the Signal Processing Unit. The following Figures show examples for protection types Ex-d “Flameproof Enclosure”, Ex-e “Increased Safety” and Ex-i “Intrinsically Safe”.

If the manufacturer's adhesive label has been broken, sealing can also be carried out using screws with cross or longitudinal holes and wire seals.

Fig. 18 Sealing the Ex-d terminal compartment

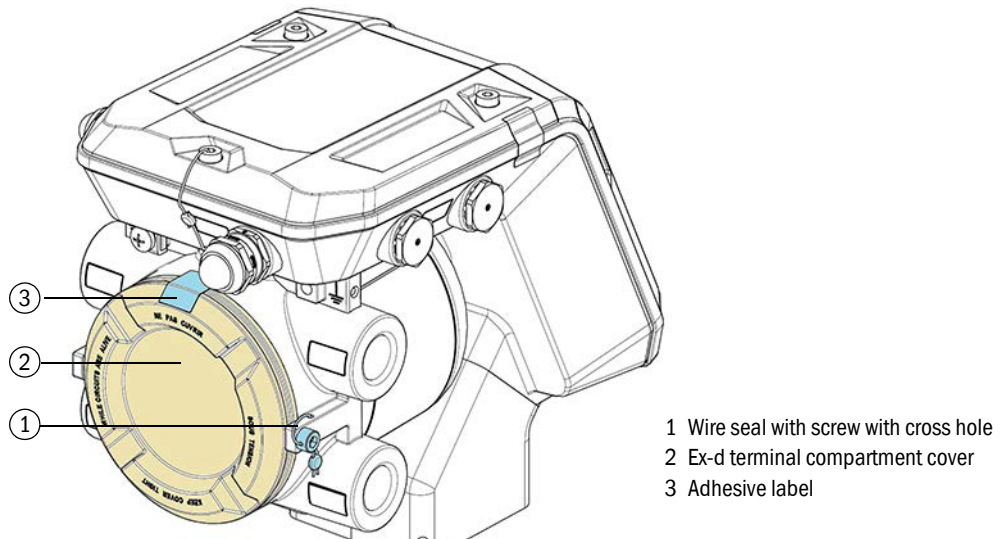
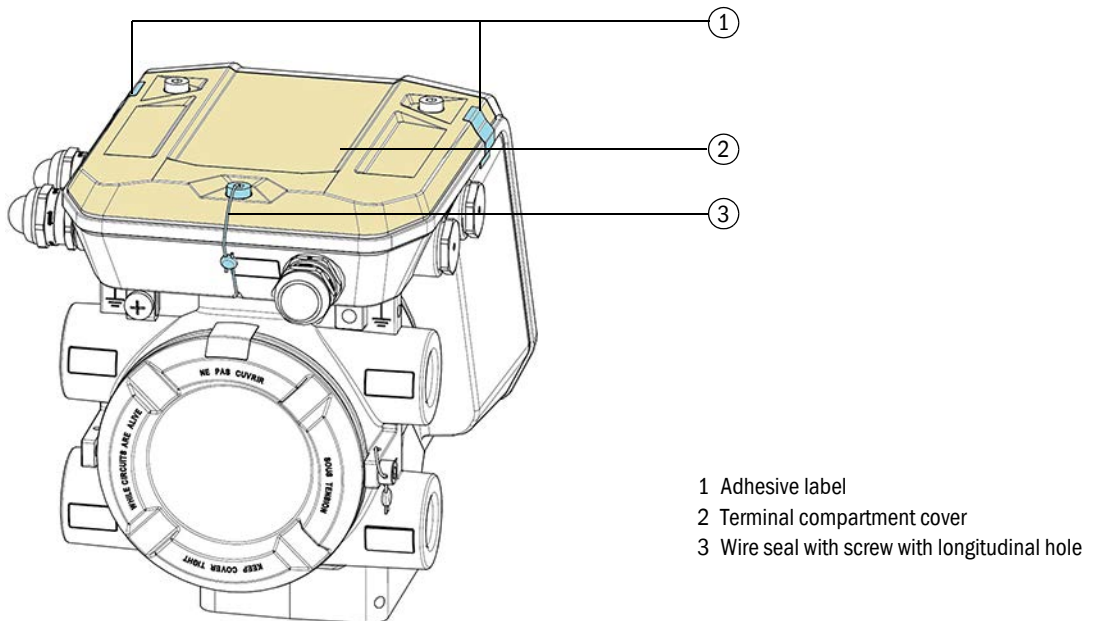



Fig. 19 Sealing the Ex-e or Ex-i terminal compartment



Seals on the transducer cover caps

The cover caps are sealed with at least one adhesive label that must be glued over the openings of the fastening screws.

2.12 **PowerIn Technology™**

	<p>WARNING: Danger when charging the battery</p> <p>The backup battery is a special hermetically sealed battery which can be stored for over 10 years without capacitance loss. The battery is designed for single use and therefore cannot be recharged.</p> <ul style="list-style-type: none"> ▶ Do not charge the battery. ▶ Contact Endress+Hauser Service for a new battery.
---	--

The highly efficient energy concept of the FLOWSIC600-XT guarantees continuous power supply via an optional integrated backup battery in the event of a mains power failure. This ensures continuous measuring operation for up to three weeks.

The backup battery is a special hermetically sealed battery which can be stored for over 10 years without capacitance loss.

If the external power supply fails, power consumption is reduced to the minimum level:

- The standard measuring rate is reduced from 10 Hz to 1 Hz.
- The cross-eyed beams for additional diagnostics support are deactivated
- The RS485, Ethernet, HART, Encoder interfaces and the analog output are deactivated.
- The frequency and pulse outputs FO.0, FO.1, DO.2 and DO.3 as well as the infrared service interface on the display are available.
- The digital display is activated.

This configuration is preconfigured at the factory. The measuring rate and the active inputs and outputs can be adapted for backup operation via the device configuration with the FLOWgate™ operating software.

The following operating time (measurement, providing measurement and diagnostics data via the above interfaces) is available for backup operation with power supply via the backup battery:

	Active I/Os for Ex-d and Ex-de (circuit: Open normally)					
Status output (DO) Pulse output (FO)	2x DO 2x FO	2x DO 1x FO	1x DO 2x FO	1x DO 1x FO	- 2x FO	Measurement without active I/O
4-path electronics	Approx. 1 week	Approx. 2 weeks	Approx. 2 weeks	Approx. 3 weeks	Approx. 1 month	Approx. 3 months
8-path electronics	Approx. 1 week	Approx. 2 weeks	Approx. 2 weeks	Approx. 3 weeks	Approx. 1 month	Approx. 2 months
1-path electronics	Approx. 2 weeks	Approx. 2 weeks	Approx. 3 weeks	Approx. 1 month	Approx. 2 months	Approx. 5 months

	Active I/Os for Ex-i (circuit: Open normally)					
Status output (DO) Pulse output (FO)	2x DO 2x FO	2x DO 1x FO	1x DO 2x FO	1x DO 1x FO	- 2x FO	Measurement without active I/O
4-path electronics	Approx. 1 month	Approx. 2 months	Approx. 2 months	Approx. 2 months	Approx. 2 months	Approx. 3 months
8-path electronics	Approx. 1 month	Approx. 1 month	Approx. 2 months	Approx. 2 months	Approx. 2 months	Approx. 2 months
1-path electronics	Approx. 2 months	Approx. 2 months	Approx. 2 months	Approx. 3 months	Approx. 3 months	Approx. 5 months

FLOWSIC600-XT

3 Installation

Hazards during installation
General information
Mechanical installation
Electrical installation

3.1 Hazards during installation

**WARNING: Hazards during installation work**

- ▶ Do not carry out any welding work on lines with meters fitted.
 - ▶ Comply exactly with mandatory and approved methods.
 - ▶ Observe and comply with regulations of the plant operator.
 - ▶ Meticulously check completed work. Ensure leak tightness.
- Otherwise hazards are possible and safe operation is not ensured.

**CAUTION: General risks during installation**

- ▶ Observe applicable valid regulations, general standards and guidelines.
- ▶ Observe local safety regulations, operating instructions and special regulations.
- ▶ Observe the safety information in → p. 12, §1.2.
- ▶ Comply with the safety requirements of Pressure Equipment Directive 2014/68/EC or ASME B31.3 when installing pressure devices including connection of various pressure devices.
- ▶ Persons carrying out installation work must be familiar with the directives and standards applicable for pipeline construction and have the corresponding qualifications, e.g. in accordance with DIN EN 1591-4.

3.2 **General information**

3.2.1 **Delivery**

The FLOWSIC600-XT is delivered preassembled in sturdy packaging.

- ▶ Inspect for transport damage when unpacking the device.
- ▶ Document any damage found and report this to the manufacturer.



NOTICE:
Do not put the FLOWSIC600-XT into operation if you notice any damage!

- ▶ Check the scope of delivery for completeness.
The standard scope of delivery comprises:
 - Measuring system FLOWSIC600-XT (meter body with Signal Processing Unit and transducers),
 - Program FLOWgate for operating, configuration and diagnostics,
 - Operating Instructions,
 - Device documentation.
- ▶ Check that the identifiers on the Signal Processing Unit and meter body (type plates) match the operating conditions.



NOTICE:
The plant operator must ensure that the upper/lower limit values shown on the type plate are not overflowed or underflowed in operation.

3.2.2 **Transport**

During all transport and storage work:

- ▶ Ensure the FLOWSIC600-XT is always well secured.
- ▶ Take measures to prevent mechanical damage.
- ▶ Ensure the ambient conditions are within the specified limits.

3.2.3 **Water pressure test in the plant (optional)**

Consultation with Endress+Hauser is mandatory when an inspection of the plant in which a FLOWSIC600-XT is installed is to be carried out by means of water pressure. Endress+Hauser evaluates and checks the inquiry as to whether the installed ultrasonic transducers can withstand the planned water pressure or whether they need to be replaced with so-called blind plugs. Forward the following information to Endress+Hauser. The meter serial number and the pressure planned for this check. If it is determined that the transducers cannot withstand the pressure, dummy plugs must be installed instead. Endress+Hauser will make a recommendation for the dummy plugs as well as for the corresponding O-rings to be used for the water pressure test (dummy plugs and O-rings must be ordered separately!).

The installation instructions for the dummy plugs can be found in the FLOWSIC600-XT Service Manual.

3.3 Mechanical installation

3.3.1 Preparations

- ▶ The following tools and materials are required to install the FLOWSIC600-XT:
 - Lifting gear or fork lift (load according to the weight specification on the type plate)
 - Box wrench with size suitable for flange installation
 - Thread seal (e.g. PTFE tape) and flange gaskets
 - Bolt lubricant
 - Leak detection spray

3.3.2 Choosing flanges, seals and other components

For flange connections only use pipeline flanges, bolts, nuts and gaskets suitable for the maximum operating pressure, maximum operating temperature as well as ambient and operating conditions (external and internal corrosion).

The FLOWSIC600-XT can be installed in straight inlet and outlet pipes depending on the installation configuration (→ p. 51, §3.3.4.1):

The inlet and outlet pipes must have the same nominal size as the meter body. The inner diameter is shown in the Data Sheet and is based on the nominal flange value and the standard. The max. permitted difference of the inner diameter of the inlet pipe from that of the meter body is 3%. The permitted difference is 1% for meter bodies with straight measuring section.

Any welding beads and burs on the flanges of the inlet pipe must be removed.

3.3.3 Requirements to the measuring point

- The meter body may be installed in a horizontal or vertical position.
 - In case of horizontal installation, the meter body must be aligned so that the planes formed by the measuring paths are horizontal. This prevents dirt in the pipeline from entering the transducer ports. Vertical installation is only possible when the measuring system is used for dry, non-condensing gases. The gas flow must be free from any foreign material, dust and liquids. Otherwise use filters and traps.
- Do not mount equipment or fittings which may adversely affect the gas flow directly before the FLOWSIC600-XT
- Seals on the flange connections between meter body and pipeline must not protrude into the pipeline. Any protrusion into the flowing gas stream may change the flow profile and thus adversely affect measuring accuracy.
- Pressure measuring devices must be connected to the pressure tap provided. The pressure inlet nozzle is marked with p_m .
- As required by the customer or as standard, the pressure taps are designed as 1/8, 1/4 or 1/2 inch NPT connection (female), depending on meter sizes and customer requirements.
- For the leak-proof connection on the pressure line, a suitable thread sealing agent (e.g. PTFE tape) must be used when the pressure connection adapter is screwed in. The leak tightness must be checked after installation and commissioning. All leaks must be repaired. Arrange the temperature sensors as shown in → Fig. 21 (unidirectional) and → Fig. 22 (bidirectional).

3.3.4

Fitting in the pipeline



NOTICE: Transport information

The lifting lugs are designed for transporting the meter only. Do not lift or transport the FLOWSIC600-XT with additional loads using these lugs.

- ▶ The FLOWSIC600-XT must not swing or tilt on the lifting gear during transport.
- ▶ Never attach lifting gear to the Signal Processing Unit or its mounting bracket and avoid contact between these parts and the lifting gear.
- ▶ Flange sealing surfaces, Signal Processing Unit housing and transducer cover caps may be damaged when the lifting gear is not attached properly.
- ▶ Take suitable protective measures to prevent any damage when carrying out other work (e.g. welding, painting) near the FLOWSIC600-XT.

Lifting requirements

Fig. 20

Lifting requirements

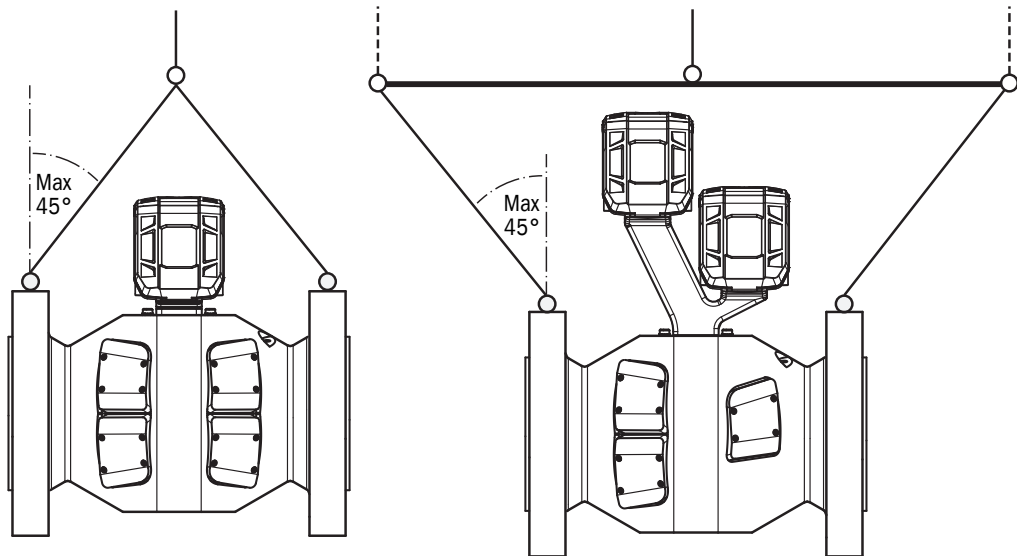

- ▶ If a lifting angle of 45° cannot be ensured due to construction of the FLOWSIC600-XT, e.g. for 2plex devices, a suitable traverse hoist must be used for lifting.
- ▶ For meters of nominal size DN80/3" and DN100/4" with double electronics (Y-neck), the lifting lugs for correct alignment of the electronics must be removed and replaced with dummy plugs.

Gas flow direction**NOTICE: Observe the gas flow direction**

- ▶ A directional arrow shows the gas flow direction in accordance with OIML R 137-1&2 (see Figure).
- ▶ The forward or main flow direction is marked with “+” and the reverse direction with “-”.
- ▶ In case of unidirectional use, ensure the meter is flowed through in the main flow direction marked with “+”.
- ▶ The measured volume is displayed with a negative sign when the meter is flowed through in reverse direction marked with “-”, .

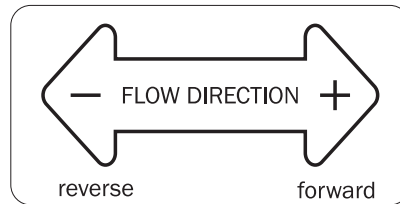

3.3.4.1 Installation configurations

Unidirectional

Fitting the FLOWSIC600-XT for unidirectional flow.

Fig. 21 Unidirectional use

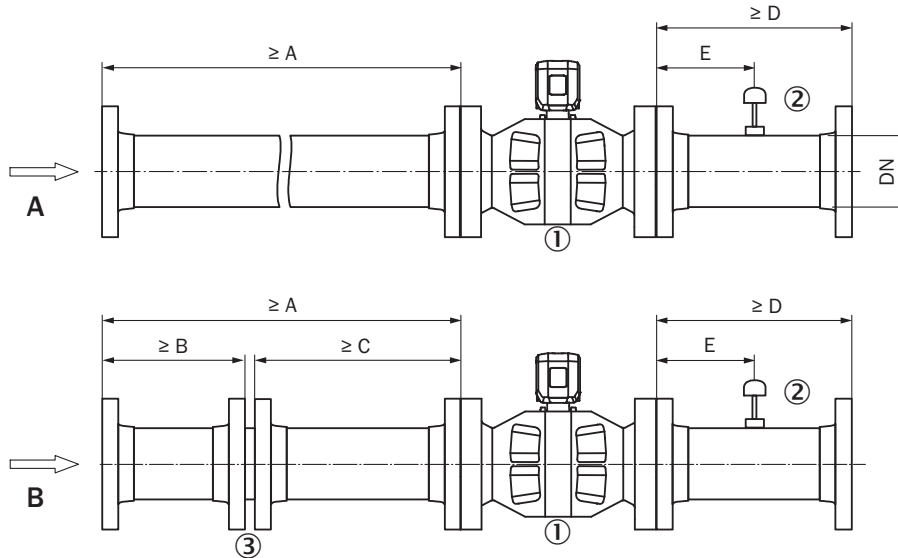

- 1. FLOWSIC600-XT
- 2. Temperature measuring point
- 3. Flow conditioner



NOTICE:

Installation configuration (B) with the flow conditioner refers to Endress+Hauser conditioner types (according to Endress+Hauser documents 9211778 and 9211779). When using CPA conditioner types, a distance between the conditioner and meter of at least 3 DN must be considered for CPA 55E inlet length and of at least 5 DN for CPA 50E inlet length. When other conditioners are used, the installation configuration can be different and must be agreed with Endress+Hauser.



In order to minimize the additional influence of errors during transfer from calibration to application, it is recommended to use the same flow conditioner as well as the same pipes, in the same orientation as when calibrating the meter. The pipes and the flow conditioner should be marked to indicate the flange alignment at the time of calibration.

Configuration 1 (A)		A	D	E
OIML R137				
4 measuring paths	Class 1.0	10 DN	3 DN	1-5 DN
8 measuring paths	Class 1.0	2 DN	3 DN	1-5 DN
8 measuring paths	Class 0.5	5 DN	3 DN	1-5 DN
2 measuring paths	Class 1.5	50 DN	3 DN	1-5 DN
AGA Report 9 4th Edition, 2022		A	D	E
4 measuring paths	Metering package performance per §6.3 ¹	10 DN	3 DN	2-5 DN
8 measuring paths	Metering package performance per §6.3 ^{1,2}	5 DN	3 DN	2-5 DN

[1] Characterized by CPA or Endress+Hauser flow conditioners.

[2] Better repeatability and linearity is achieved by using a flow conditioner; both configurations meet the performance requirements of AGA 9.

Configuration 2 (B)						
OIML R137		A	B	C	D	E
4 measuring paths	Class 1.0	5 DN	2 DN	3 DN	3 DN	1-5 DN
4 measuring paths	Class 0.5	10 DN	2 DN	8 DN	3 DN	1-5 DN
8 measuring paths	Class 1.0/0.5	5 DN	2 DN	3 DN	3 DN	1-5 DN
2 measuring paths	Class 1.5	20 DN	10 DN	10 DN	3 DN	1-5 DN
AGA Report 9 4th Edition, 2022		A	B	C	D	E
4 measuring paths	Metering package performance per §6.3 ^{1,2}	10 DN	5 DN	5 DN	3 DN	2-5 DN
8 measuring paths	Metering package performance per §6.3 ^{1,2}	5 DN	2 DN	3 DN	3 DN	2-5 DN

[1] Characterized by CPA or Endress+Hauser flow conditioners.

[2] Better repeatability and linearity is achieved by using a flow conditioner; both configurations meet the performance requirements of AGA 9.



Local requirements for the inlet section may vary.



The maximum gas velocity in the pipe is limited to 40 m/s in configurations with flow conditioner.

Bidirectional

Fitting the FLOWSIC600-XT for bidirectional flow.

Fig. 22

Bidirectional use without flow conditioner (configuration A)

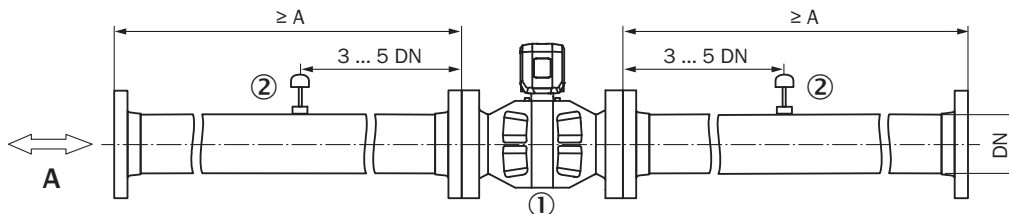

- 1. FLOWSIC600-XT
- 2. Alternative temperature measuring points
- 3. Flow conditioner

Configuration 1 (A)		
OIML R137		A
4 measuring paths	Class 1.0	10 DN
8 measuring paths	Class 1.0	5 DN
8 measuring paths	Class 0.5	5 DN
2 measuring paths	Class 1.5	50 DN
AGA Report 9 4th Edition, 2022		A
4 measuring paths	Metering package performance per §6.3 ¹	10 DN
8 measuring paths	Metering package performance per §6.3 ^{1,2}	5 DN

Fig. 23 Bidirectional use with conditioner (configuration B)

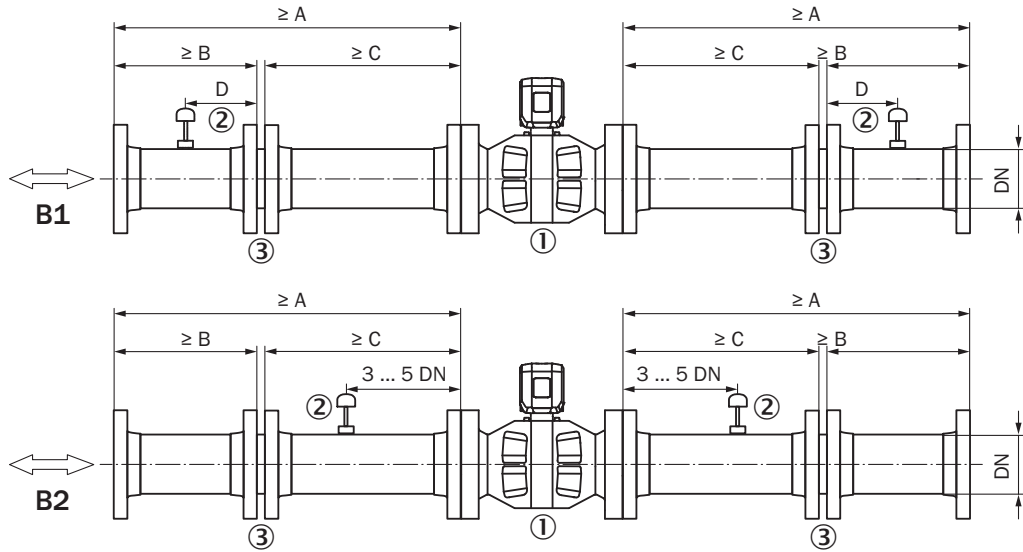

- 1. FLOW-SIC600-XT
- 2. Alternative temperature measuring points
- 3. Flow conditioner

NOTICE: Installation configuration (B) with the flow conditioner refers to Endress+Hauser conditioner types (according to Endress+Hauser documents 9211778 and 9211779). When using CPA conditioner types, a distance between the conditioner and meter of at least 3 DN must be considered for CPA 55E inlet length and of at least 5 DN for CPA 50E inlet length. When other conditioners are used, the installation configuration can be different and must be agreed with Endress+Hauser.

+i In order to minimize the additional influence of errors during transfer from calibration to application, it is recommended to use the same flow conditioner as well as the same pipes, in the same orientation as when calibrating the meter. The pipes and the flow conditioner should be marked to indicate the flange alignment at the time of calibration.

Configuration 2 (B)					
OIML R137		A	B	C	D
4 measuring paths	Class 1.0	5 DN	2 DN	3 DN	1 DN
4 measuring paths	Class 0.5	10 DN	2 DN	8 DN	1 DN
8 measuring paths	Class 1.0/0.5	5 DN	2 DN	3 DN	1 DN
AGA Report 9 4th Edition, 2022		A	B	C	D
4 measuring paths	Metering package performance per §6.31.2	10 DN	5 DN	5 DN	1 DN
8 measuring paths	Metering package performance per §6.31.2	6 DN	3 DN	3 DN	1-2 DN

[1] Characterized by CPA or Endress+Hauser flow conditioners.

[2] Better repeatability and linearity is achieved by using a flow conditioner; but both configurations meet the performance requirements of AGA 9.



Local requirements for the inlet section may vary.



The maximum gas velocity in the pipe is limited to 40 m/s in configurations with flow conditioner.

Flange-to-flange unidirectional

Fitting the FLOWSIC600-XT for unidirectional flange-to-flange use.

Fig. 24

Unidirectional flange-to-flange use

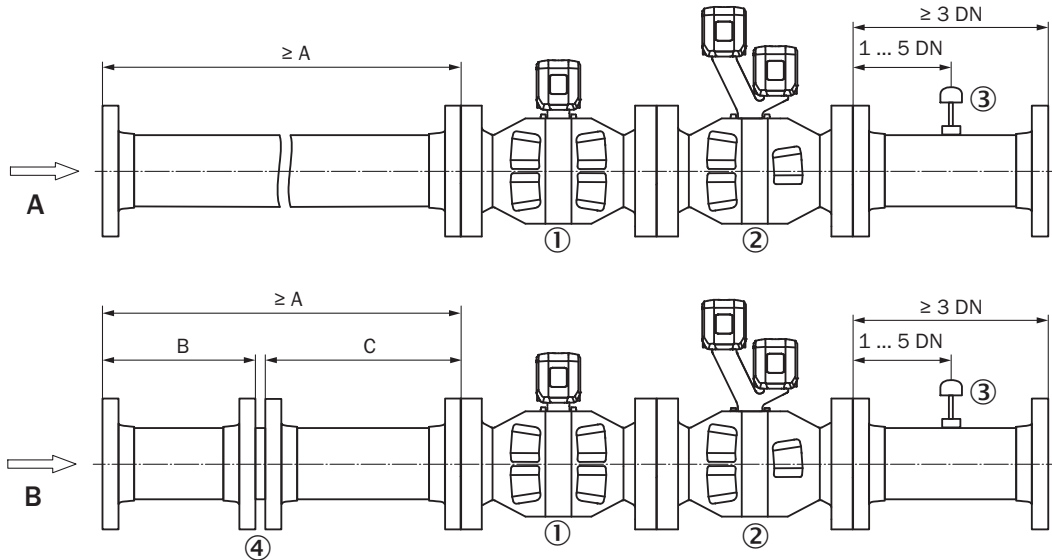

- 1. FLOWSIC600-XT (8 paths)
- 2. FLOWSIC600-XT (4+1 paths)
- 3. Alternative temperature measuring points
- 4. Flow conditioner

NOTICE: Meters must be designed as full-bore devices for a continuous series connection with flange-to-flange mounting of the two gas meters. Likewise, the ultrasonic transducer frequency of both meters must be designed different in order to avoid possible mutual interference. This is particularly true when using Endress+Hauser and non-Endress+Hauser device combinations.

NOTICE: Installation configuration (B) with the flow conditioner refers to Endress+Hauser conditioner types (according to Endress+Hauser documents 9211778 and 9211779). When using CPA conditioner types, a distance between the conditioner and meter of at least 3 DN must be considered for CPA 55E inlet length and of at least 5 DN for CPA 50E inlet length. When other conditioners are used, the installation configuration can be different and must be agreed with Endress+Hauser.

+i In order to minimize the additional influence of errors during transfer from calibration to application, it is recommended to use the same flow conditioner as well as the same pipes, in the same orientation as when calibrating the meter. The pipes and the flow conditioner should be marked to indicate the flange alignment at the time of calibration.

Configuration 1 (A)	
OIML R137	A
Class 1.0	7 DN

Configuration 1 (A)	
Class 0.5	7 DN ²
AGA Report 9 4th Edition, 2022	A
“Metering package performance” according to Appendix C	7 DN

Configuration 2 (B)			
OIML R137	A	B	C
Class 1.0	5 DN	2 DN	3 DN
Class 0.5	7 DN	2 DN	5 DN
AGA Report 9 4th Edition, 2022	A	B	C
„Metering package performance“ according to Appendix C with CPA 55E	5 DN	2 DN	3 DN
“Metering package performance” according to Appendix C with CPA 50E	10 DN	5 DN	5 DN

[1] The value increases by 1 DN when using meters with 2D / SD overall length.

[2] Class 0.5 is only achieved for the 8-path meter in this configuration.



The maximum gas velocity in the pipe is limited to 40 m/s in configurations with flow conditioner.

Flange-to-flange bidirectional

Fitting the FLOWSIC600-XT for bidirectional flange-to-flange use.

Fig. 25 Bidirectional flange-to-flange use without flow conditioner (configuration A)

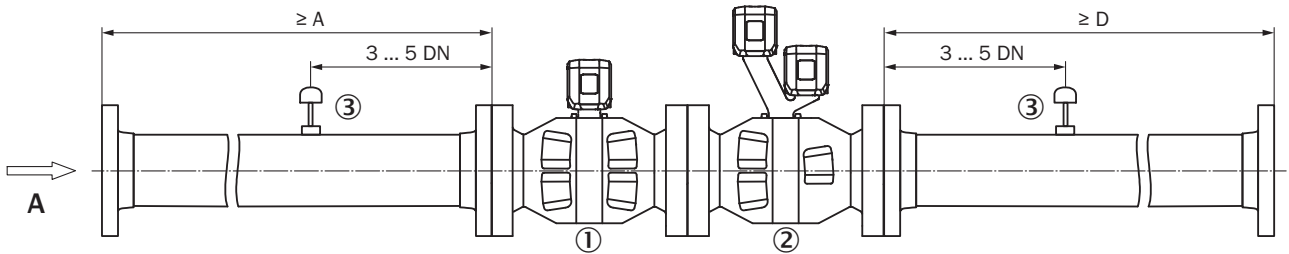

- 1. FLOWSIC600-XT (8 paths)
- 2. FLOWSIC600-XT (4+1 paths)
- 3. Alternative temperature measuring points

Fig. 26 Bidirectional flange-to-flange use with flow conditioner (configuration B)

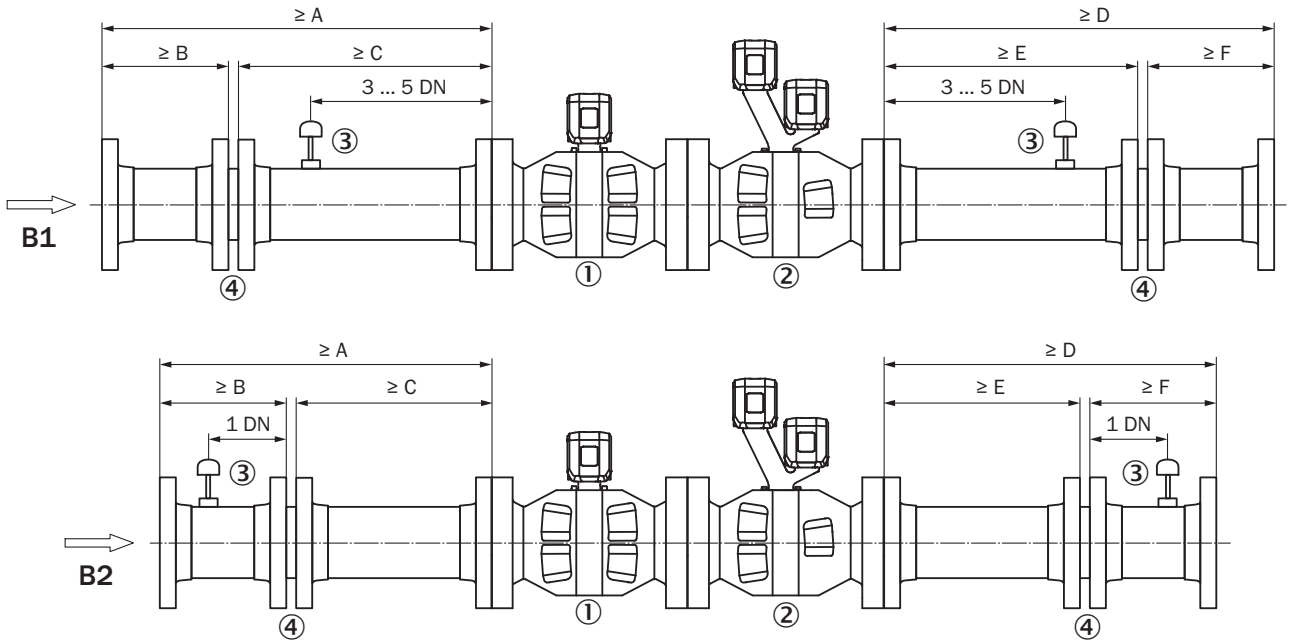

- 1. FLOWSIC600-XT (8 paths)
- 2. FLOWSIC600-XT (4+1 paths)
- 3. Alternative temperature measuring points
- 4. Flow conditioner



NOTICE:

Installation configuration (B) with the flow conditioner refers to Endress+Hauser conditioner types (according to Endress+Hauser documents 9211778 and 9211779). When using CPA conditioner types, a distance between the conditioner and meter of at least 3 DN must be considered for CPA 55E inlet length and of at least 5 DN for CPA 50E inlet length. When other conditioners are used, the installation configuration can be different and must be agreed with Endress+Hauser.



In order to minimize the additional influence of errors during transfer from calibration to application, it is recommended to use the same flow conditioner as well as the same pipes, in the same orientation as when calibrating the meter. The pipes and the flow conditioner should be marked to indicate the flange alignment at the time of calibration.

Configuration 1 (A)		
OIML R137	A	D
Class 1.0	7 DN	10 DN
Class 0.5	7 DN ²	10 DN ²
AGA Report 9 4th Edition, 2022	A	D
“Metering package performance” according to Appendix C with CPA 50E	7 DN	10 DN

Configuration 2 (B1)						
OIML R137	A	B	C	D	E	F
Class 1.0	6 DN	2 DN	4 DN	5 DN	3 DN	2 DN
Class 0.5	7 DN	2 DN	5 DN	10 DN	8 DN	2 DN
AGA Report 9 4th Edition, 2022	A	B	C	D	E	F
“Metering package performance” according to Appendix C with CPA 50E	10 DN	5 DN	5 DN	10 DN	5 DN	5 DN

Configuration 2 (B2)						
OIML R137	A	B	C	D	E	F
Class 1.0	5 DN	2 DN	3 DN	6 DN	4 DN	2 DN
Class 0.5	7 DN	2 DN	5 DN	10 DN	8 DN	2 DN
AGA Report 9 4th Edition, 2022	A	B	C	D	E	F
“Metering package performance” according to Appendix C with CPA 50E	10 DN	5 DN	5 DN	10 DN	5 DN	5 DN

[1] The value increases by 1 DN when using meters with 2D / SD overall length.

[2] Class 0.5 is only achieved for the 8-path meter in this configuration.



The maximum gas velocity in the pipe is limited to 40 m/s in configurations with flow conditioner.

3.3.4.2 **Fitting the FLOWSIC600-XT in the pipeline**

- 1 Use the lifting gear to position the FLOWSIC600-XT in the desired location in the pipeline.
- 2 Lead the pipelines free of tension to the device being fitted.
- 3 Check for correct seating and alignment of the flange gaskets after installing the flange bolts, but prior to tightening. The gaskets must not project into the area through which the gas flows.
- 4 Align the FLOWSIC600-XT so that the offset of the inner diameters (bore) between inlet section, meter body and outlet section is as small as possible.
- 5 Insert the remaining fastening bolts and tighten the nuts cross-wise. The tightening torque applied must not be lower than specified in the project planning.
- 6 Fit the pressure sensing line between the pressure tap and pressure transmitter.
- 7 Slowly increase the pressure in the pipeline.

 **NOTICE: Observe allowed pressure change**
The pressure change within the measuring section must not exceed 0.5 MPa/min in order to protect ultrasonic transducers and seals.

- 8 Carry out a leak tightness check on the pipeline (in accordance with the pipeline manufacturer's specifications). In case of a water pressure test in the installation, see Section 3.2.3 "Hydrostatic test in the installation" for further information.

 The FLOWSIC600-XT meter body in the nominal widths DN80/3" or DN100/4" (interchangeable) is flangeless with a blind hole thread. The hole pattern corresponds to the DIN or ANSI standard, depending on the design.

Fig. 27

Borehole diagram

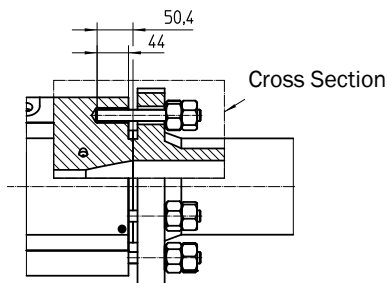

The threaded bolt is to be screwed through the washer of the connection pipe into the blind hole thread of the meter body and fixed with a lock nut. Observe the maximum screw-in depth. (see Table "Mounting sets")

Table 4 Mounting sets

Nominal size [inch]	Pressure levels	Flange sealing surface to thread base clearance	Part	Endress+Hauser Part No.
3	CL150	34	Mounting set BZ 3" A0150RF B7/2H VZ3.1	2096366
3	CL300	40	Mounting set BZ 3" 300/600 4"300 B7/2H VZ3.1	2096372
3	CL600	45		
4	CL300	40		
3	PN016	35	Mounting set BZ 3" PN16/25/40 4"PN16 VZ3.1	2096373
3	PN025	35		
3	PN040	35		
4	PN010/16	35		
4	PN025/40	43	Mounting set BZ 3" PN63/4"PN25 40 5.6 VZ3.1	2096374
3	PN016	43		
4	CL150	34	Mounting set BZ 4" A0150RF B7/2H VZ3.1	2096371
4	CL600	50,4	Mounting set BZ 4" A0600RF B7/2H VZ3.1	2096375
4	PN063	51	Mounting set BZ 4" PN063b! 5.6 VZ3.1	2096376

3.3.5 Signal Processing Unit alignment

The Signal Processing Unit can be rotated for the best possible view on the display and safe cable routing (→ Fig. 28). A stop on the housing prevents the Signal Processing Unit from being turned by more than 330°:

- 1 Loosen the two screws on the meter body with an SW 3 Allen key.
- 2 Turn the meter body to the desired position.
- 3 Retighten the three screws on the meter body neck that were previously loosened (5NM).

Fig. 28

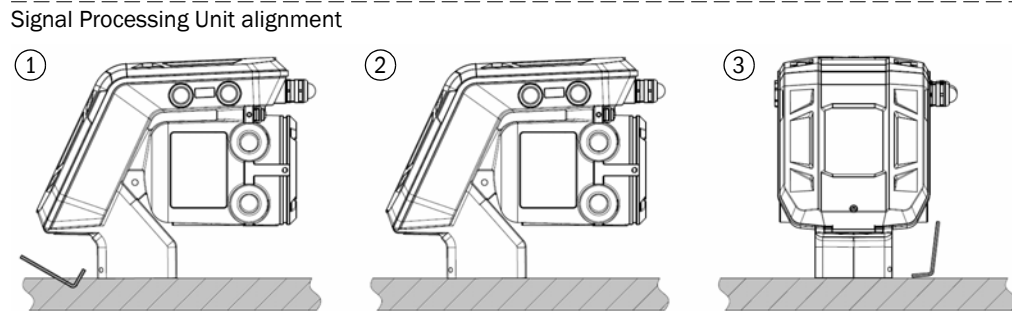

3.4 **Electrical installation**

3.4.1 **Requirements for use in potentially explosive atmospheres**

The FLOWSIC600-XT is as suitable for use in potentially explosive atmospheres classified in Zone 1 and Zone 2.

IECEX

Ex db ia op is [ia Ga] IIA /IIC T4 Gb
 Ex db eb ia op is [ia Ga] IIA/IIC T4 Gb
 Ex ia op is IIA/IIC T4 Ga

ATEX

II 2 (1) G Ex db ia op is [ia Ga] IIA /IIC T4 Gb
 II 2 (1) G Ex db eb ia op is [ia Ga] IIA/IIC T4 Gb
 II 1G Ex ia op is IIA/IIC T4 Ga

NEC/CEC (US/CA)

Explosion-proof/non-flammable:

Cl I, Div. 1 Group D, T4 / Ex db ia [ia Ga] IIA T4 Gb / Cl I, Zone 1 AEx db ia op is [ia Ga] IIA T4 Gb

Cl I, Div. 1 Groups B, C, D, T4 / Ex db ia [ia Ga] IIC T4 Gb / Cl I, Zone 1 AEx db ia op is [ia Ga] IIC T4 Gb

Intrinsically safe:

Cl I, Div. 1 Group D T4 / Ex ia IIA T4 Ga / Cl I, Zone 0, AEx ia op is IIA T4 Ga

Cl I, Div. 1 Groups A, B, C, D, T4 / Ex ia IIC T4 Ga / Cl I, Zone 0, AEx ia op is IIC T4 Ga

- Ambient temperature: $-40^{\circ}\text{C} < T_{\text{amb}} < 70^{\circ}\text{C}$, restricted range, see type plate on Signal Processing Unit
- Process temperature: $-46^{\circ}\text{C} < T_{\text{gas}} < 180^{\circ}\text{C}$, restricted range, see type plate on Signal Processing Unit
- Process temperature with remote Signal Processing Unit electronics:
 $-196^{\circ}\text{C} < T_{\text{gas}} < 230^{\circ}\text{C}$, restricted range, see type plate on Signal Processing Unit



NOTICE:

The rise in the ambient temperature outside the pipeline due to a hot pipeline must be taken into account.

The user must ensure the ambient temperature around the electronics housing does not exceed the maximum permitted ambient temperature specified on the FLOWSIC600-XT type plate.

General requirements for installation

- ▶ The documentation for hazardous area classification (zone classification) according to EN/IEC60079-10 must be available.
- ▶ The equipment must be verified as suitable for use in the classified area.
- ▶ After installation, an initial test run of the complete equipment and the plant must be performed according to EN/IEC60079-17 before regular operation is started.

	<p>WARNING: Risk of explosion</p> <ul style="list-style-type: none"> ▶ In the exclusively intrinsically safe variant of the FLOWSIC600-XT, the ultrasonic transducers may only be connected and disconnected by Endress+Hauser Service when under voltage. Safe separation among themselves and from other non-intrinsically safe power circuits must always be ensured so as not to endanger the intrinsic safety. An uncontrolled movement of the disconnected transducer cable should therefore be prevented. <p>In all other variants of FLOWSIC600-XT, the ultrasonic transducers may only be connected and disconnected when under voltage only when this is specified by the device identification. The identification must contain as a minimum the specification [ia Ga] whereby this is applicable only for the danger area concerned as well as the specified ignition group.</p> <ul style="list-style-type: none"> ▶ Opening the enclosure and removing the cover caps for the ultrasonic transducers when under voltage is not allowed (exception: under the conditions already described). ▶ The display cover may be opened during operation, for example, in order to swap the battery.
---	--

	<p>NOTICE:</p> <p>Please observe the specific conditions of use in potentially explosive atmospheres, → p. 14, § 1.3.3.</p>
---	--

	<p>NOTICE:</p> <ul style="list-style-type: none"> ▶ When 3/4" NPT cable inlets are used, components screwed in, e.g. cable glands, must be installed in the grip with at least 5 thread turns and tightened with a minimum torque of 90 Nm (800 in-lbs). Use additional suitable sealants, e.g. PTFE sealing tape, to attain IP protection class IP 66 or IP 67.
---	--

	<p>NOTICE: Class I, Division 1</p> <p>Wiring to or from this device entering or leaving the system enclosure must use wiring methods suitable for Class I, Division 1 hazardous locations as appropriate for the installation.</p>
---	---

Operating conditions for the ultrasonic transducers

The FLOWSIC600-XT is designed solely for use under normal atmospheric conditions in potentially explosive atmospheres. The atmospheric conditions must be within the following ranges:

- Ambient pressure range 80 kPa (0.8 bar) to 110 kPa (1.1 bar)
- Air with normal oxygen content, normally 21 percent by volume
- Maximum operating altitude 2,000 mNN

The ambient temperature must be within the range specified on the Signal Processing Unit type plate.

The meter body becomes part of the pipeline as soon as the FLOWSIC600-XT is installed in the pipeline. The wall of the pipeline and the meter body are then deemed a zone-separating barrier. The figure below helps in understanding the different situations for a possible application and shows which operating conditions apply.

Fig. 29

Ex zones

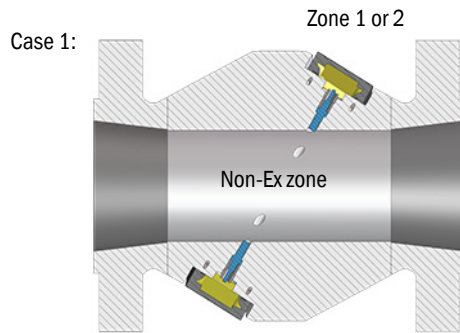

- The pipeline contains a non-explosive mixture. The gas mixture can be combustible.
- Gas pressure and gas temperature may be within the range specified by the tag on the meter body.

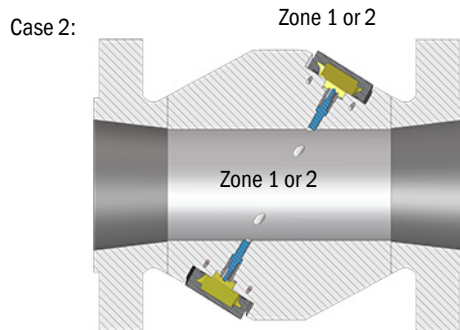

- The area inside the pipeline is classified as potentially explosive atmosphere Zone 1 or 2.
- Gas pressure must be in the range from 80 kPa (0.8 bar) to 110 kPa (1.1 bar) (normal atmospheric conditions).
- Gas temperature must be within the permitted ambient temperature range specified by the type plate on the Signal Processing Unit.

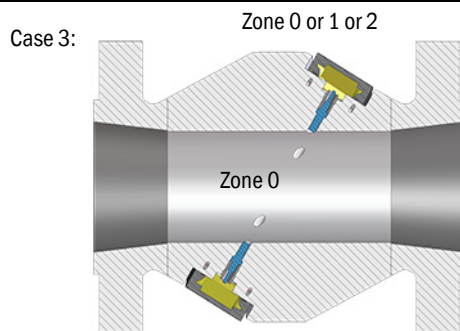

- The area inside the pipeline is classified as potentially explosive atmosphere in Zone 0.
- Gas pressure must be in the range from 80 kPa (0.8 bar) to 110 kPa (1.1 bar) (normal atmospheric conditions).
- Gas temperature must be within the permitted ambient temperature range specified by the type plate on the Signal Processing Unit.

Additional requirements for operation of ultrasonic transducers in Zone 0 classified areas

FLOWSIC600-XT is either available in the completely intrinsically safe variant and is identified with device protection level Ga after the temperature class or the identification contains, among others [ia Ga], which identifies the intrinsically safe control of the ultrasonic transducers.

Operation of ultrasonic transducers in Zone 0

The ultrasonic transducers are suitable for operation in Zone 0 at atmospheric conditions, i.e. ambient temperature -40 °C to 70 °C and ambient pressure 0.8 bar to 1.1 bar(a).

If ultrasonic transducers with titanium housing are to be used in Zone 0, it must be assured that the medium does not transport solid parts (like dust or other particles) which could cause an ignition hazard. Otherwise, transducers made from stainless steel must be used.

After installation and following every de-installation and reinstallation of the ultrasonic transducers, the leak tightness must be appropriately checked. During operation, the leak tightness must be periodically checked and the seals replaced if necessary. After de-installation and before every reinstallation the seals must be replaced according to the original assembly. Seals can be ordered from Endress+Hauser (part number and serial number from type plate at Signal Processing Unit).

3.4.2 General connection of the FLOWSIC600-XT

Fig. 30 Connection diagram FLOWSIC600-XT

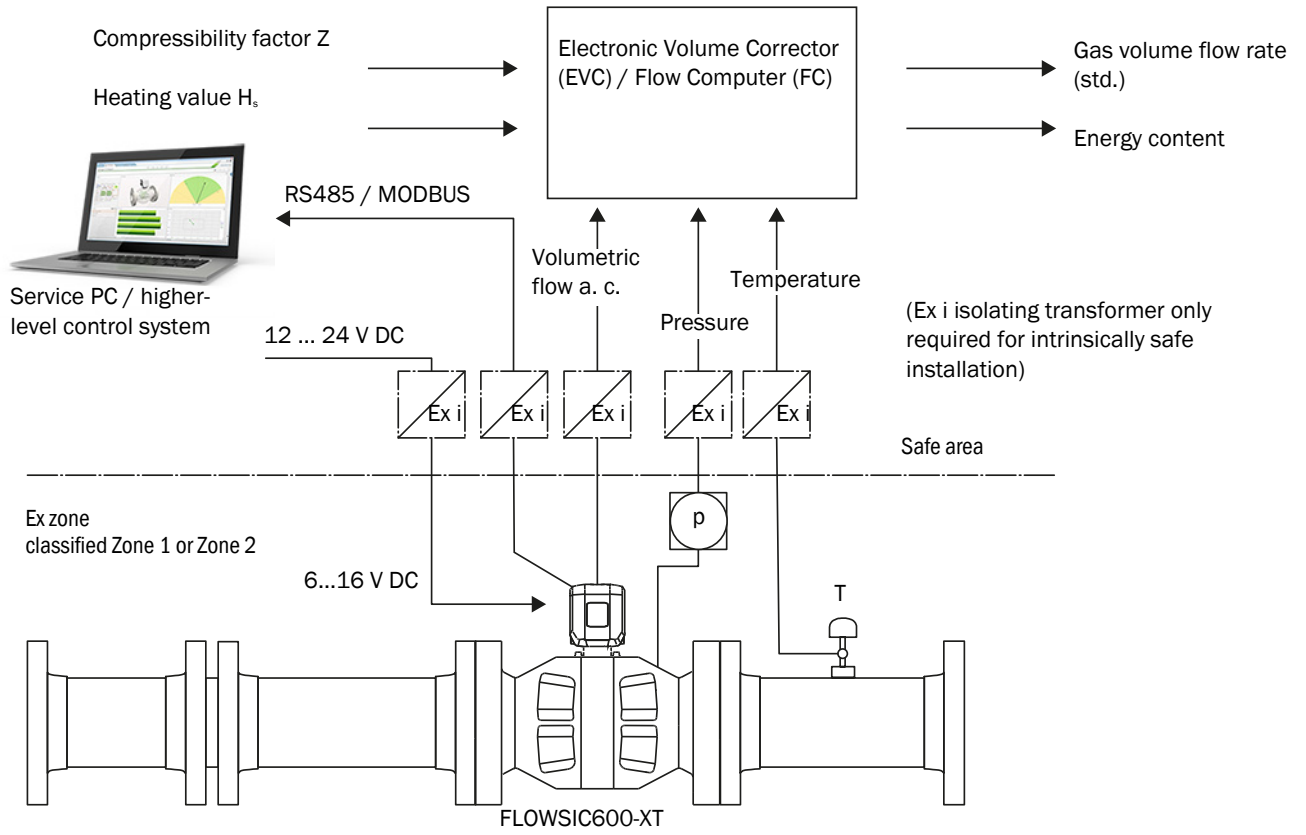

3.4.3 Criteria for electrical connection

Installation work → p. 48, §3.3 must be completed.

3.4.4 Electrical connections

The Signal Processing Unit enclosure of the FLOWSIC600-XT comprises a flameproof enclosure and an adjacent separate chamber. With Ex-e wiring (→ Fig. 32), the Ex-d inputs and outputs run through a line duct to the Ex-e terminals in the Ex-e terminal compartment.

Fig. 31 Ex-d enclosure version

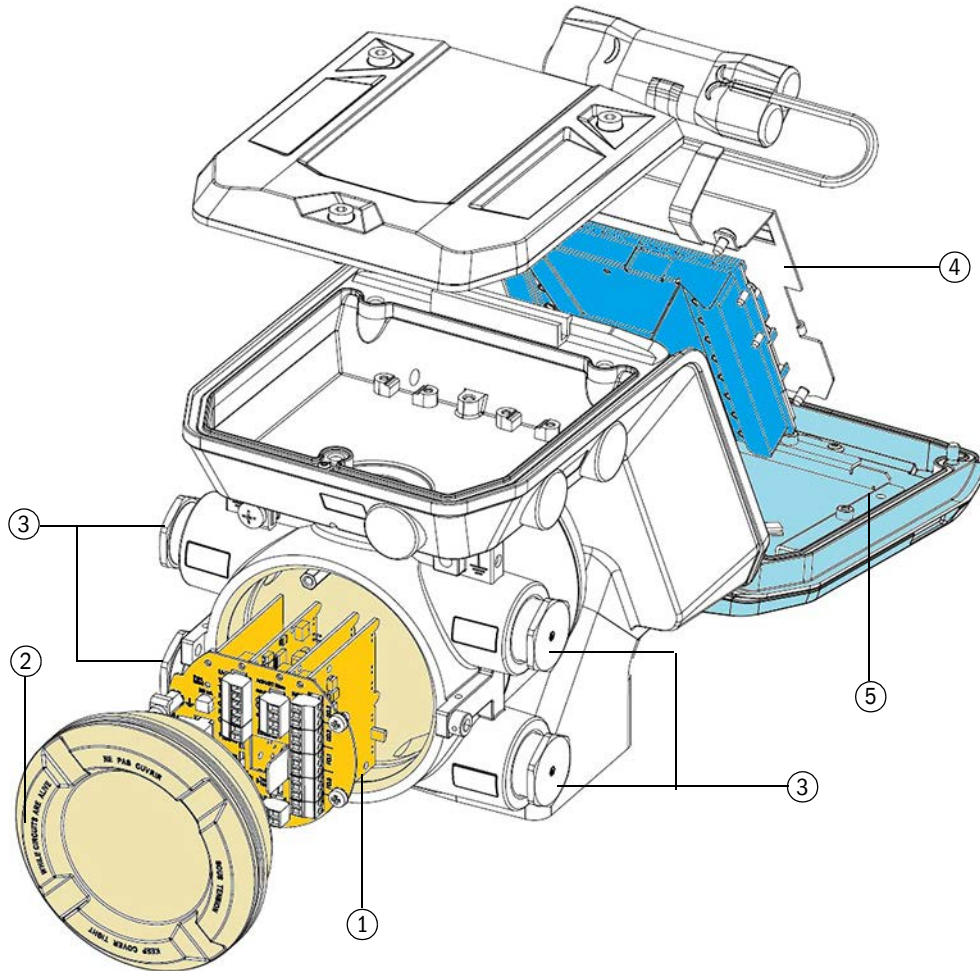

- 1 Flameproof enclosure with I/O electronics
- 2 Ex-d terminal compartment cover
- 3 Cable gland (4 M25 3/4x), with flameproof sealing plug;
cable ducts must be ordered separately or provided by the customer
- 4 Ex-i transducer electronics with cover and backup battery
- 5 Display unit

Fig. 32 Ex-de enclosure version

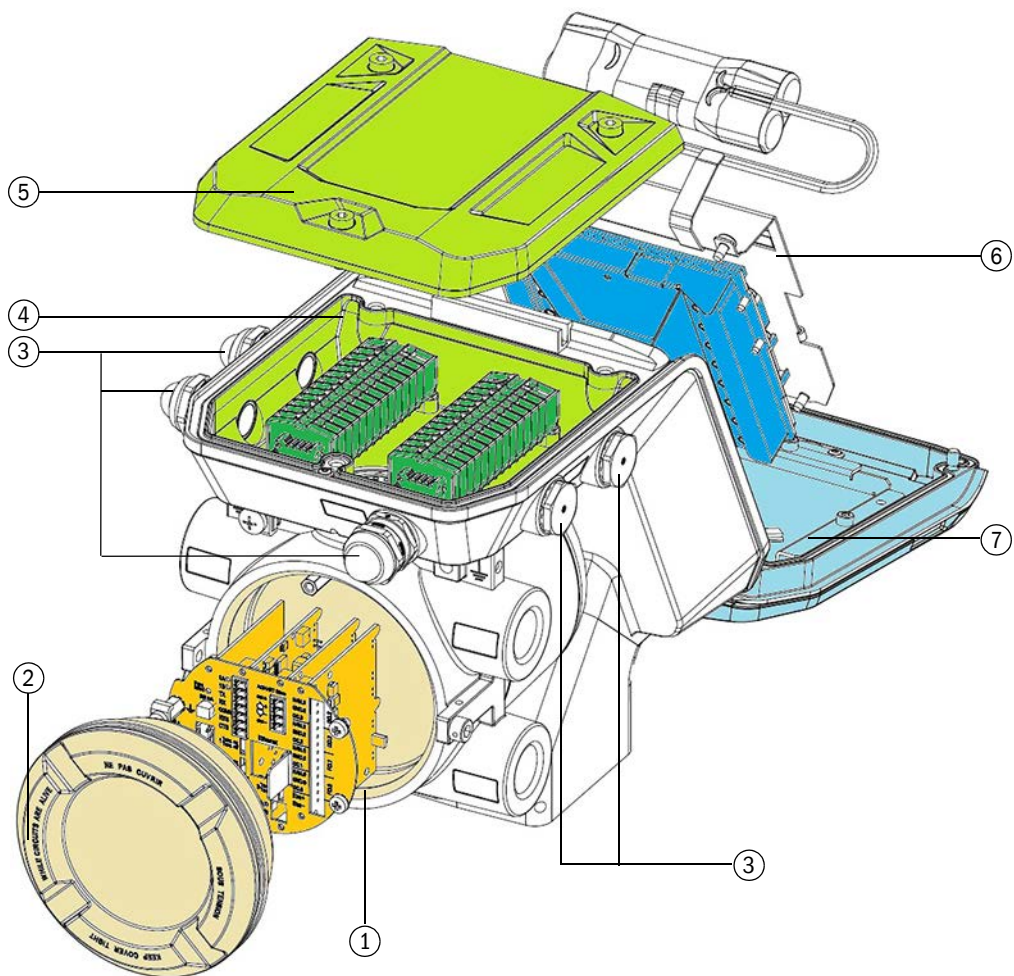

- 1 Flameproof enclosure with I/O electronics
- 2 Ex-d terminal compartment cover
- 3 Cable gland (5x M20 or 1/2" NPT)
- 4 Ex-e terminal compartment
- 5 Ex-e terminal compartment cover
- 6 Ex-i transducer electronics with cover and backup battery
- 7 Display unit

Fig. 33

Ex-i enclosure version

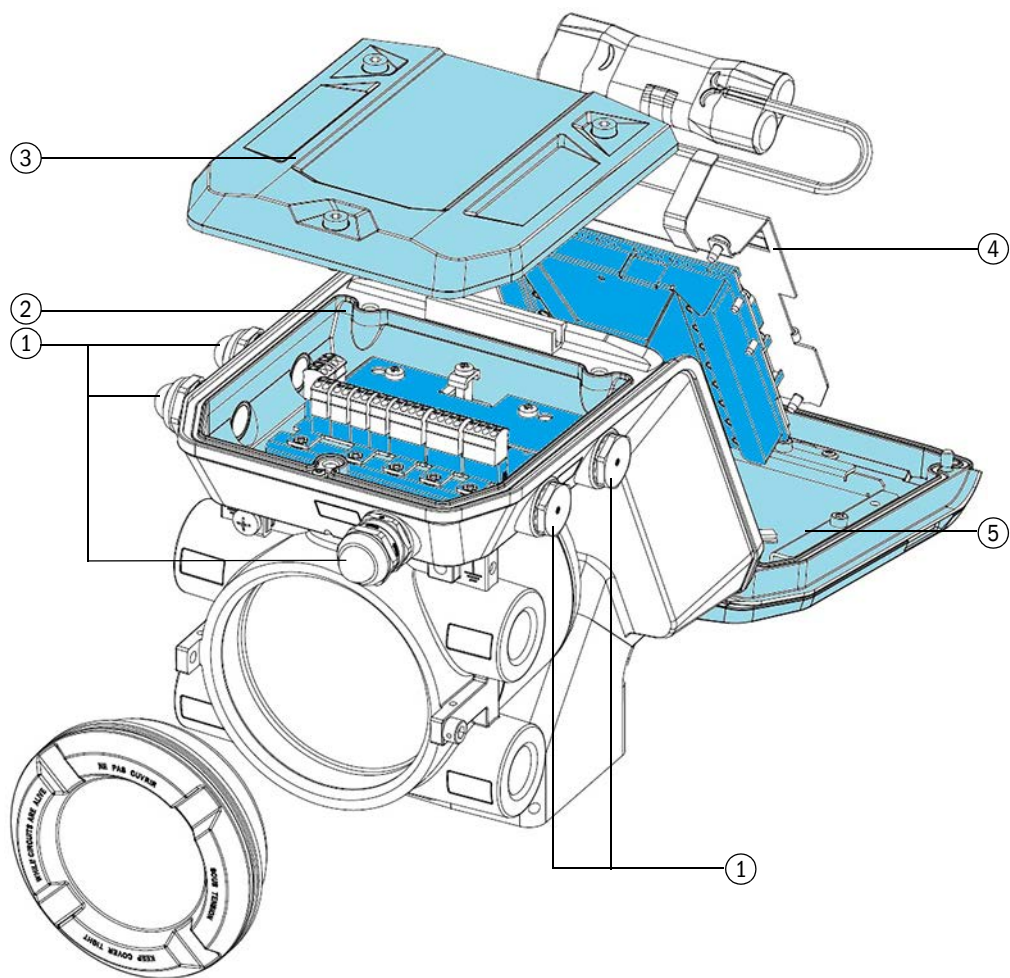

- 1 Cable gland (5x M20 or 1/2" NPT)
- 2 Ex-i terminal compartment
- 3 Ex-i terminal compartment cover
- 4 Ex-i transducer electronics with cover and backup battery
- 5 Display unit

3.4.5 Available input/output configurations

See the model name on the type plate for the interface configuration:

Fig. 34

Model name (example)

F6A - 4P 3D 08 - EA 1A - T218

I/O Configuration / Data Interfaces

► Complete description of the model name, see → p. 169, §9.6.

Table 5 Available input/output configurations

Model name code	DO.0 Status Output 1	DO.1 Status Output 2	FO.2 Pulse Output 1	FO.3 Pulse Output 2	RS485.1	RS485.2	RS485.3	Ethernet	AO Analog Output	Encoder	HART p/T Modules
<i>Intrinsically safe Version (Ex i)</i>											
1A	x	x	x	x	x	x	x				
1J	x	x	x	x	x	x				x	
2A	x	x	x	x	x		x				x
<i>Flameproof enclosure / increased type of protection (Ex d / e)</i>											
1B	x	x	x	x	x	x	x		x		
1D	x	x	x	x	x	x			x	x	
1E	x	x	x	x	x	x		x	x		
1L	x	x	x	x	x	x					
2B	x	x	x	x	x		x		x		x
2D	x	x	x	x	x				x	x	x
2E	x	x	x	x	x			x	x		x

3.4.6

Cable specifications**NOTICE: Requirements on cables and installation**

- ▶ Pay attention to the requirements in EN 60079-14 when selecting the cables and during installation!
- ▶ FLOWSIC600-XT must be grounded according to EN 60079-14.
- ▶ Further legal requirements must be observed for use in explosive atmospheres.
- ▶ Because of the danger of crosstalk, switching signals and the data signals of the RS485 should not be routed in a cable with a common shield.

Power supply 6 ... 16 V DC (Ex i) / 12 ... 24 V DC (Ex d/de)

	Specification	Remark
Type of cable	2 wires ¹⁾	Connect shielding (if present) to ground terminal
Min./ max. cross-section	Ex i: 0.25 mm ² / 1 mm ² ; 1.5 mm ² without wire end (24 / 18 AWG; 16 AWG without wire end) Ex d/de: 0.5 mm ² / 2.5 mm ² (20 / 12 AWG)	
Maximum cable length	Depending on loop resistance; minimum input voltage must be 6V DC with Ex i and 12V DC with Ex d/de	Note for Ex i when safety barriers are used: The cable length is limited to 75 m for ignition group IIC
Cable diameter	6 ... 12 mm	Fixing range of the cable glands

¹⁾ OZ-BL-CY 2x1.5 mm² is only suitable for the power supply of the FLOWSIC600-XT.

Digital output, current output, encoder, pressure and temperature sensors

	Specification	Remark
Type of cable	Twisted pair, per switching output, ²⁾ common shield	Connect shield to ground terminal
Min./ max. cross-section	2 x 0.5 mm ² / 1 mm ² (20-18 AWG)	Do not connect unused conductor pairs and prevent them from accidental short-circuit
Maximum cable length	Loop resistance: ≤ 250 Ohm	
Cable diameter	6 ... 12 mm	Fixing range of the cable glands

²⁾ RE-2Y (St)Yv with n x 2 x 0.5 mm² (n pairs) is suitable for transmitting the switching signals.

Serial port (RS485)

	Specification	Remark
Type of cable	Twisted pair, shielded, ³⁾ cable impedance approx. 100 ... 150 Ω low cable capacitance: ≤100 pF/m	Connect shield to ground terminal
Min./ max. cross-section	2 x 0.5 mm ² / 1 mm ² (20-18 AWG)	Do not connect unused conductor pairs and prevent them from accidental short-circuit
Maximum cable length	300 m at 0.5 mm ² 500 m at 0.75 mm ²	
Cable diameter	6 ... 12 mm	Fixing range of the cable glands

³⁾ RE-2Y (St)Yv with n x 2 x 0.5 mm² (n pairs) is suitable for transmitting the RS485 signals including the RS485 auxiliary voltage.

Ethernet

	Specification	Remark
Type of cable	Cat 5 or higher	

3.4.7

Checking the cable loops

Check the cable loops to verify that the cables are connected correctly.

- ▶ Disconnect both ends of the cable of the loop to be tested. This is to prevent connected devices from interfering with the measurement.
- ▶ Test the entire cable loop between Signal Processing Unit and terminal device by measuring the loop resistance.
- ▶ To test the insulation resistance as well, the cables must be disconnected from the electronic module before using the insulation resistance tester.



WARNING: Risk of explosion

- ▶ In non-intrinsically safe installations, the terminal boxes may only be opened if the system is disconnected from the power supply.
- ▶ In non-intrinsically safe installations, the cables may only be disconnected if the system is disconnected from the power supply.
- ▶ The terminal compartment cover must only be opened if the system is disconnected from the power supply and only 10 minutes or more after the system has been switched off, or the area is known to be non-hazardous.



NOTICE:

- Applying test voltage to the cables before disconnecting them from the electronics module can seriously damage the electronics module.
- ▶ Reconnect all cables after the loop resistance test.



NOTICE:

Incorrect cabling may cause failure of the FLOWSIC600-XT! This will invalidate warranty claims. The manufacturer assumes no liability for consequential damage.

3.4.8 Connection parameters of inputs and outputs

3.4.8.1 Safety-relevant parameters Ex-i



NOTICE:

The FLOWSIC600-XT with intrinsically safe inputs and outputs (Ex ia version) contains a shunt Zener diode barrier. Grounding the FLOWSIC600-XT must satisfy the requirements for grounding intrinsically safe power circuits in compliance with IEC 60079-14.



For intrinsically safe installation of FLOWSIC600-XT measurement devices, Endress+Hauser recommends the use of the Endress+Hauser FLPS multibarrier as multi-channel supply and input isolation amplifier.
Part Nos.: 2098122 and 2098136 (with Ethernet)
For more information, see the “FLPS Multibarrier” Operating Instructions.

Table 6 Safety-relevant parameters Ex-i

Model name code	Safety-relevant parameters according to ATEX/IECEx	Safety-relevant parameters according to CSA
1A	→ Fig. 67, → p. 138	→ Fig. 76, → p. 147
1J	→ Fig. 68, → p. 139	→ Fig. 77, → p. 148
2A	→ Fig. 69, → p. 140	→ Fig. 78, → p. 149

3.4.8.2 Connection parameters Ex-d and Ex-e

	<p>NOTICE: Safety-relevant parameters Ex-i</p> <p>The connection parameters in → Table 7 do not apply for the Ex-i installation. Safety-relevant parameters for Ex-i installation, see → p. 138, §9.1 for installation according to ATEX/IECEX and → p. 147, §9.2 for installation according to CSA.</p>
---	---

Table 7 Connection parameters Ex-d and Ex-e

	Ex-d (→ p. 77)	Ex-e (→ p. 79)	Connection parameters
Power supply	Power	1 + 2	10.8 ...26.4 VDC, max. 400 mA
Switching outputs	DO.0/FO.0	13+14	Open Collector, max. 30 VDC, max. 50 mA, switching frequency DC ...10 kHz, recommended switching current $2\text{ mA} < I_c < 20\text{ mA}$, load resistance $R_{load} = U / I_c$, alternative NAMUR characteristic
	DO.1/FO.1	15+16	
	DO.2	17+18	
	DO.3	19+20	
Encoder	Encoder	9+10	NAMUR, 1.2 kbit/s, UART protocol 7E1
Active current output	AO	5-8	24 VDC, 3.6 ...24 mA, alternative external auxiliary voltage max. 30 V,
Pressure and temperature sensor system	pT (HART Master)	3+4 ^[1]	24 VDC, max. 24 mA,
RS485	RS485.1	21+22 ^[1]	EIA-485, max. 57.6 kbit/s, termination 150 Ohm switchable Configuration of the RS485.1 interface at the factory: - Protocol type: MODBUS-RTU - Modbus configuration: FL600XT (standard) - Baud rate: 38,400 baud - Bit protocol: 8N1
	RS485.2	3+4 ^[1]	
	RS485.3	9+10 ^[1]	
Ethernet	Ethernet	9-12 ^[1]	10/100 Mbit/s, protocol Modbus TCP

[1] If configured
Configuration options and power input of possible configurations, see → p. 166, §9.4.

3.4.8.3

Ex-d terminal compartment**Open the Ex-d terminal compartment**

- 1 Loosen the securing screw on the Ex-d terminal compartment cover with an SW5 Allen key. Ensure the tip of the screw no longer extends into the groove of the cover.

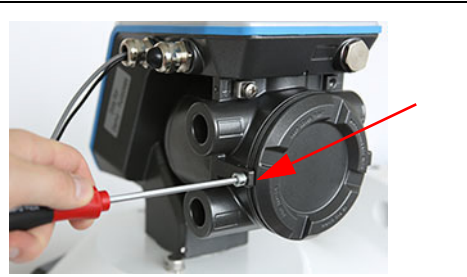

- 2 Unscrew the terminal compartment cover. To loosen the cover, position a suitable tool (e. g. the shaft of a ring spanner) in the provided recesses in the cover.

**Closing the Ex-d terminal compartment**

- 1 Make sure that the threads are clean. Grease the threads with an assembly paste as required.
- 2 Screw the terminal compartment cover back on handtight. Do not use a tool for this work step.



- 3 Tighten the securing screw on the Ex-d terminal compartment cover with an SW5 Allen key until the tip of the screw slightly enters the material of the cover.

Do not operate the device without the securing screw!

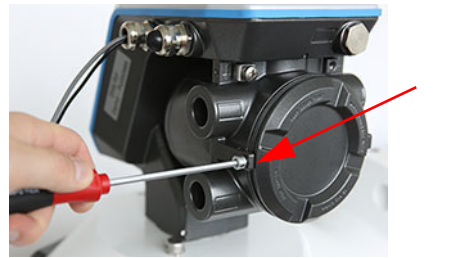

Terminal assignment Ex-d terminal compartment

► Connection parameters, see → p. 75, §3.4.8.2.

Fig. 35

Terminal assignment Ex-d terminal compartment

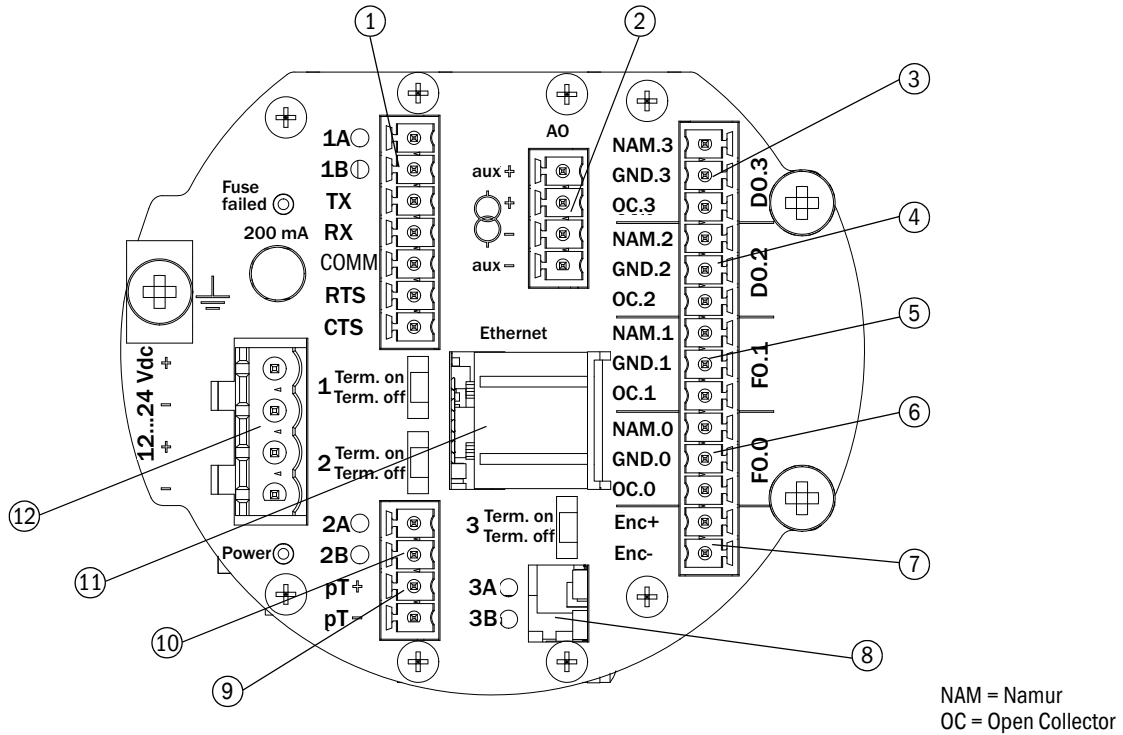

- | | |
|--------------------------|-------------------------------|
| 1 RS485.1 | 7 Encoder |
| 2 AO (analog output) | 8 RS485.3 |
| 3 DO.3 Status output | 9 pT (HART master) |
| 4 DO.2 Status output | 10 RS485.2 |
| 5 DO.1/FO.1 Pulse output | 11 Ethernet (when configured) |
| 6 DO.0/FO.0 Pulse output | 12 Power |

3.4.8.4

Ex-e terminal compartment**Opening the Ex-e terminal compartment**

- 1 Loosen the 3 screws (captive) of the Ex-e terminal compartment cover with an SW4 Allen key.



- 2 Put the terminal compartment cover in the holder provided.

**Closing the Ex-e terminal compartment**

- 1 Ensure the sealing area is free from contamination.
- 2 Position the cover on the Ex-e terminal compartment.
- 3 Tighten the 3 screws (captive) of the Ex-e terminal compartment cover with an SW4 Allen key (torque 5 Nm).



Terminal assignment Ex-e terminal compartment

Fig. 36 Terminal assignment Ex-e terminal compartment

Without Ethernet				With Ethernet							
Vdc +		1	13	OC.0	NAM.0	Vdc +	1	13	OC.0	NAM.0	
Vdc -		2	14	GND.0		Vdc -	2	14	GND.0		
pT +	2A	3	15	OC.1	NAM.1	pT +	2A	3	15	OC.1	NAM.1
pT -	2B	4	16	GND.1		pT -	2B	4	16	GND.1	
aux +		5	17	OC.2	NAM.2	aux +		5	17	OC.2	NAM.2
⊖+		6	18	GND.2		⊖+		6	18	GND.2	
⊖-		7	19	OC.3	NAM.3	⊖-		7	19	OC.3	NAM.3
aux -		8	20	GND.3		aux -		8	20	GND.3	
3A	Enc +	9	21	1A	TX	TX +	Ethernet	9	21	1A	TX
3B	Enc -	10	22	1B	RX	TX -		10	22	1B	RX
CTS		11	23		COMM	RX +		11	23		COMM
RTS		12	24	n.c.		RX -		12	24	n.c.	

► Connection parameters, see → p. 75, §3.4.8.2.

Table 8 Ex-e: Alternative terminal assignments and configurations

	Assignment	Alternative	Alternative ^[1]
1	Power supply		
2			
3	HART p & T	RS485.2 (MOD), Modbus RTU	-
4			
5	AO, alternative external auxiliary voltage	-	
6			
7			
8			
9	RS485.3 (MOD), Modbus RTU	Encoder	Ethernet
10			
11	-	-	
12			
13	DO.0/FO.0	DO.0/FO.0	-
14	Open Collector	NAMUR	
15	DO.1/FO.1	DO.1/FO.1	
16	Open Collector	NAMUR	
17	DO.2	DO.2	
18	Open Collector	NAMUR	
19	DO.3	DO.3	
20	Open Collector	NAMUR	
21	RS485.1 (MOD), Modbus RTU	-	
22			
23	Not used	-	
24	Not used		

[1] If configured

3.4.8.5 Ex-i terminal compartment

- ▶ Opening the Ex-i terminal compartment:
Proceed as described in Section “Opening the Ex-e terminal compartment”, → p. 78, §3.4.8.4 to open and close the Ex-1 terminal compartment.

Terminal assignment Ex-i terminal compartment

Connections in the Ex-i terminal compartment are labeled corresponding to the input/output configuration selected.

Fig. 37 Terminal assignment Ex-i terminal compartment (example)

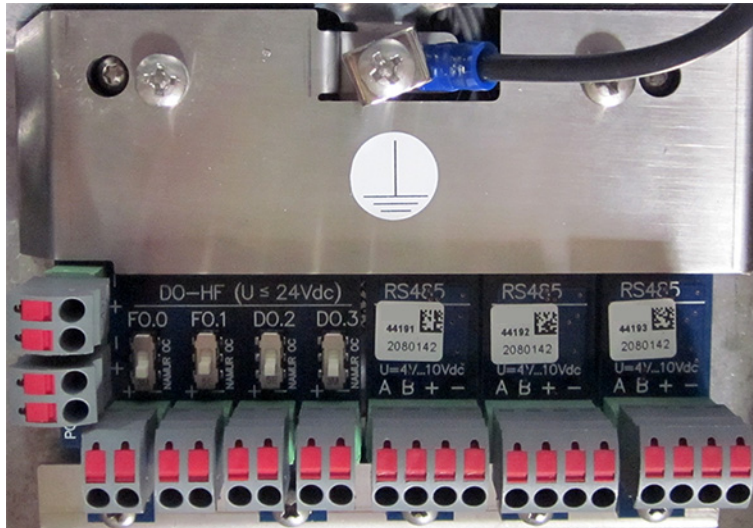

- ▶ Safety-relevant parameters, see → p. 74, §3.4.8.1.

3.4.9 Connecting the optional backup battery

 **NOTICE:**
Make sure the external power supply is active before connecting the backup battery.
Otherwise the backup battery is immediately active.

- ▶ Swivel the display unit downwards, → p. 111, §5.3.3.1.
- ▶ Connect the backup battery, → p. 112, §5.3.3.3.
- ▶ Swivel the display unit upwards and lock, → p. 113, §5.3.3.4.

Fig. 38 Backup battery connected

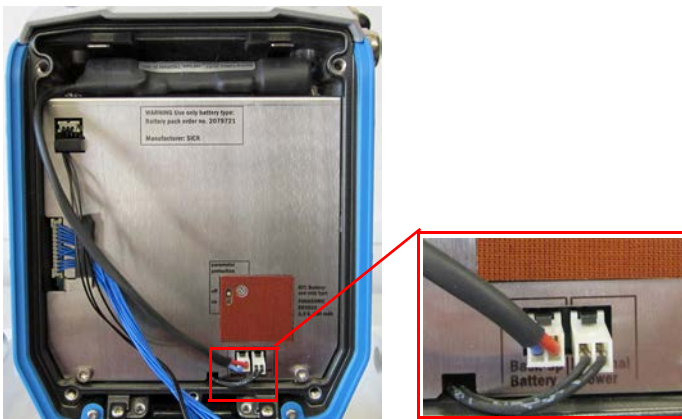

3.4.10 **Connecting external pressure and temperature sensors to the electronics**

It is possible to connect external pressure and temperature transmitters via HART to the electronics of the FLOWSIC600-XT. Select the electronics version with the option “HART p/T modules” in this case. This is available in all three Ex versions (Ex i, Ex d, Ex e) (Table 3 “Available input/output configurations” p. 52).

When the transmitters of the HART masters are connected, the FLOWSIC600-XT electronics polls the connected HART transmitters for pressure and temperature cyclically when the parameters are set accordingly (Register #4430 “UART3_Protocol” → “HART-PT”). The cycle times can be set between 2 and 60 seconds in Register #4700 “PT_UpdateCycle”. Both cycle times are updated within this cycle.

The interface parameters are automatically set to the values 1200 Baud, 801.

The pressure transmitter address must be stored in Register #4750 “Pressure_HART_Addr” and the temperature transmitter address in Register # 4751 “Temperature_HART_Addr”.

To use the read-in values, for example, in a volume converter, the raw values for pressure are available in Register #4723 “Pressure_Raw” and for temperature in Register #4728 “Temperature_Raw”. The transmitter statuses are available in Registers #4727 “Pressure_Status” (for pressure) and #4732 “Temperature_Status” (for temperature).

FLOWSIC600-XT

4 Commissioning and operation

General information

Parameter display on the display

Commissioning with the FLOWgate™ operating software

Function check after commissioning

Sealing

4.1

General information

- All activities described in § 3 “Installation” must be completed before commissioning. A laptop/PC with the FLOWgate™ operating software installed is required for commissioning.
- The commissioning should be documented with a Commissioning Protocol. The document “FLOWSIC600-XT Commissioning Protocol” is included in the scope of delivery of the FLOWsIC600-XT and is available in paper form or in the associated product package at www.endress.com. The completed Commissioning Protocol must be filed with the FLOWsIC600-XT device documentation.
- The FLOWsIC600-XT is zero adjusted or flow calibrated when delivered to the plant operator. The zero adjust comprises the 3-D measurement of the meter body, zero-flow and sound velocity test as well as other system specific tests which belong to the manufacturing and quality assurance process. The flow calibration is performed on a flow calibration test stand (calibration test facility).
- Usually, flow calibration for fiscal devices is performed at a test pressure that corresponds as closely as possible to the mean working pressure of the intended point of use. This defines the possible operating pressure range depending on the selected substitute or calibration value (p_{fix}). This results in the following absolute pressure ranges for a Class 1.0 or Class 0.5 measurement according to OIML R137-2012.

Class 1.0		
p_{fix} [bar]	p_{min} [bar]	p_{max} [bar]
1 ... <5	1	2 p_{fix}
5 ... <26	0.5 p_{fix}	3 p_{fix}
≥ 26	0.33 p_{fix}	4 p_{fix}

Class 0.5		
p_{fix} [bar]	p_{min} [bar]	p_{max} [bar]
1	1	2 p_{fix}
≥ 2	0.5 p_{fix}	3 p_{fix}

- All parameters, determined by the aforementioned tests, as well as design specific data are preset and stored in the FLOWsIC600-XT in a non-volatile memory before delivery. Generally, the parameters are protected by a password. Additionally a Parameter write lock in the Signal Processing Unit prevents metrology relevant parameter changes.



NOTICE: Measures in a metrologically secured area

If stipulated by national regulations, measures on the device in the metrologically secured area after commissioning may be carried out only under official supervision.

- ▶ This must be coordinated with the authorities before carrying out the measures.
- ▶ All measures must be carried out on the basis of this Manual and, when necessary, the Service Manual (Part No. 8019178).

In all other cases, the output parameters of the FLOWsIC600-XT can be adapted on site by trained staff.

- The commissioning of FLOWsIC600-XT is supported by the field setup wizard in the FLOWgate™ operating software, → p. 90, §4.3.

4.2 **Parameter display on the display**

The FLOWSIC600-XT is delivered already configured according to customer specifications. It is recommended to check the parameters and settings.

4.2.1 **Opening the display protective flap**

<p>1 Loosen the screw on the display protective flap with an SW3 Allen key.</p>	
<p>2 Swivel down the display protective flap.</p>	



NOTICE: Display protective flap

Do not remove the display protective flap.
 Always keep the display protective flap closed when the display is not in use!
 After the end of the work, screw the display protective flap tight.

4.2.2 Display and operating elements

The FLOWVIC600-XT display comprises an LCD display for measuring screens and configuring, 4 buttons for menu navigation and the possibility to attach an infrared/USB adapter (Part No. 6060602) for data communication.

Fig. 39 Display and operating elements

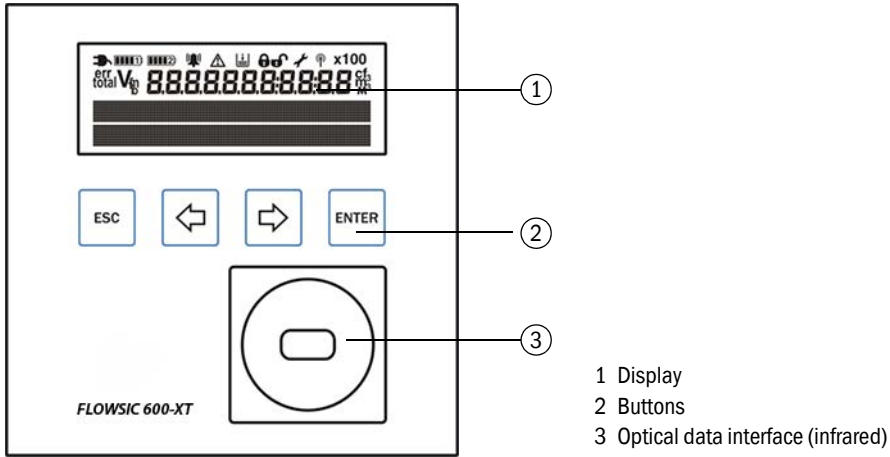

- 1 Display
- 2 Buttons
- 3 Optical data interface (infrared)

4.2.3 Display in the symbol bar

Table 9

Buttons

	In menu
Esc	Returns to next higher level of the operator menu.
←	Toggles between single menu entries on one level.
→	
ENTER	Calls up a submenu.

Table 10

Symbols

Symbol	Significance	Description
	External power supply	Always shown, blinks for faults in the external power supply.
	Device status: Malfunction	The device has an error, the measured value is invalid.
	Device status: Warning	The device has a warning, the measured value is still valid.
	Registered events	Events have occurred since the last event summary reset.
	Parameter locking switch closed	Metrologically relevant parameters are protected against changing; modifications are registered in the Metrology logbook.
	Parameter locking switch open	Metrologically relevant parameters can be changed; the modifications are not saved in the Metrology logbook.
	Configuration mode	Configuration mode is active, parameters can be changed on the device.

4.2.4 **Configurable standard display**

The standard display comprises 2 display pages that can be toggled by pressing a button. Each of the three available lines (meter level display + 2x dot matrix) can be configured individually for each display page.

Meter level display

The following values are available for the meter level display:

Table 11 Meter level display

Line No.	Value	Display example
0	No display	
1	Volume at flowing conditions, forward, uninterrupted	+V 000012345 m ³
2	Volume at flowing conditions, reverse, uninterrupted	-V 000012345 m ³
3	Volume at flowing conditions, forward, interrupted	+errV 000000123 m ³
4	Volume at flowing conditions, reverse, interrupted	-errV 000000123 m ³
5	Volume at flowing conditions, forward, total	+totV 000012468 m ³
6	Volume at flowing conditions, reverse, total	-totV 000012468 m ³
7 [1]	Volume at base conditions, forward, uninterrupted	+ V _b 000012345 m ³
8 [1]	Volume at base conditions, reverse, uninterrupted	- V _b 000012345 m ³
9 [1]	Volume at base conditions, forward, interrupted	+errV _b 000000123 m ³
10 [1]	Volume at base conditions, reverse, interrupted	-errV _b 000000123 m ³
11 [1]	Volume at base conditions, forward, total	+totV _b 000012468 m ³
12 [1]	Volume at base conditions, reverse, total	-totV _b 000012468 m ³

[1] Only visible when volume conversion is active

Dot matrix display

The following values are available for the dot matrix display:

Table 12 Dot matrix display

Line No.	Value	Display example
0	No display	
1	Date/time	18.08.2015 13:25:21
2	Gas velocity	VOG 12.34 m/s
3	Sound velocity	SOS 430.34 m/s
4	Operational flow rate	Q 1324.12 m ³ /h
5 ^[1]	Base flow rate	Qb 1324.12 m ³ /h
6 ^[1]	Mass flow rate	mf 17.61 kg/h
7	Pressure	P 51.23 bar
8	Temperature	T 18.31 °C
9 ^[1]	Conversion factor	C 52.123
10 ^[1]	Compressibility	K 0.96321
11	Volume at flowing conditions, forward, uninterrupted	+V 000012345 m ³
12	Volume at flowing conditions, reverse, uninterrupted	-V 000012345 m ³
13	Volume at flowing conditions, forward, interrupted	+Ve 000000123 m ³
14	Volume at flowing conditions, reverse, interrupted	-Ve 000000123 m ³
15	Volume at flowing conditions, forward, total	+Vt 000012468 m ³
16	Volume at flowing conditions, reverse, total	-Vt 000012468 m ³
17 ^[1]	Volume at base conditions, forward, uninterrupted	+Vb 000012345 m ³
18 ^[1]	Volume at base conditions, reverse, uninterrupted	-Vb 000012345 m ³
19 ^[1]	Volume at base conditions, forward, interrupted	+Vbe 000000123 m ³
20 ^[1]	Volume at base conditions, reverse, interrupted	-Vbe 000000123 m ³
21 ^[1]	Volume at base conditions, forward, total	+Vbt 000012468 m ³
22 ^[1]	Volume at base conditions, reverse, total	-Vbt 000012468 m ³
23 ^[1]	Mass, forward, uninterrupted	+M 000012345 t _n
24 ^[1]	Mass, reverse, uninterrupted	-M 000012345 t _n
25 ^[1]	Mass, forward, interrupted	+Me 000000123 t _n
26 ^[1]	Mass, reverse, interrupted	-Me 000000123 t _n
27 ^[1]	Mass, forward, total	+Mt 000012468 t _n
28 ^[1]	Mass, reverse, total	-Mt 000012468 t _n

[1] Only visible when volume conversion is active

4.2.5

Menu structure

The following Table shows an overview of the menu structure on the display.

Table 13 Menu structure

Menu item	Significance
Standard display 1	Configurable display page
Standard display 2	Configurable display page
Device status	Device status
Current events	Current events overview
Current event list	Current events list
Event summary	Event history overview
Event summary list	Event history overview
Last event reset	History events reset timepoint
Measurement values	Meter measured values
+V and -V	Volume at flowing conditions, uninterrupted
+Ve and -Ve	Volume at flowing conditions, interrupted
+Vt and -Vt	Volume at flowing conditions, total
Q and VOG	Flow rate and gas velocity
VOG and SOS	Gas velocity and sound velocity
P(i) and T(i)	Pressure and temperature for internal measured value correction
P(e) and T(e)	Pressure and temperature for volume conversion
FO and AO	Pulse frequency and analog output value
Volume conversion^[1]	Volume conversion (only visible when option active)
+Vb and -Vb	Volume at base conditions, without errors
+Vbe and -Vbe	Volume at base conditions, with errors
+Vbt and -Vbt	Volume at base conditions, total
+M and -M	Mass, without errors
+Me and -Me	Mass volume, with errors
+Mt and -Mt	Mass total
Qb and mf	Standard flow rate and mass flow rate
P and T	Pressure and temperature for volume conversion
C and K	Conversion factor and compressibility
Z and Zn	Real gas factors for operation and standard state
Device Information	Electronics type plate
Measuring point	Measuring point identifier
SN device	Device serial number
SN electronics	Signal Processing Unit electronics serial number
SN meter body	Meter body serial number
Firmware version	Firmware version
Firmware CRC	Firmware checksum
Firmware date	Firmware release date
Metrology CRC	Checksum for metrological parameters
Min. oper. pressure	Minimum operating pressure
Max. oper. pressure	Maximum operating pressure
Impulse factor	Impulse factor

[1] Only visible in configuration with integrated EVC

4.3 Commissioning with the FLOWgate™ operating software

4.3.1 Connecting to the device

A data connection can be established with the device using the optical data interface and the infrared/USB adapter HIE-04 (Part No. 6050602).

This interface serves to configure the FLOWsic600-XT. The infrared/USB adapter has an USB 2.0 interface. This interface provides the connection to the PC and transfers the FLOWsic600-XT data.

+i A device driver software must first be installed to operate the adapter on a PC. The device driver software can be downloaded at www.endress.com.

- 1 Install the device driver software before connecting the USB plug to the PC.
- 2 Connect the USB plug to the PC.
- 3 Fit the infrared/USB adapter to the infrared interface as shown (→ Fig. 40), a magnet integrated in the reading head retains the adapter.
A cable holder is integrated in the display protective flap to prevent unintentional turning or loosening of the reading head.

Fig. 40 Aligning the infrared/USB adapter

Correct alignment



Wrong alignment



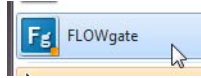

- 4 Install the FLOWgate™ operating software.
The FLOWgate operating software™ and the associated manual can be downloaded at www.endress.com.
- 5 Click on the FLOWgate™ icon to start FLOWgate™: 
- 6 Add the FLOWsic600-XT to the Device Manager of the FLOWgate™ operating software and create a connection to the device.
- 7 Login to the device as user “Admin”.

+i Please take your personal password from the delivery documentation. Otherwise the standard password for the Administrator is valid: 3333

- 8 Start the field setup wizard and follow the step-by-step instructions.

4.3.2 **Field setup wizard**

 **NOTICE:** Parameter changes are first written to the device when commissioning has been completed when using the field setup wizard.

 **NOTICE:** Configuration mode must be active to change parameters.

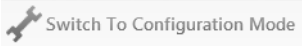
- ▶ To activate configuration mode, click:

- ▶ Otherwise click on the symbol in the toolbar.

4.3.2.1 **Device identification**

Serial number and specific device values

- ▶ Check the parameters entered:
Check the serial numbers and specific device values against the type plate.

Device information

- ▶ Compare the model name against the type plate and ensure the FLOWSIC600-XT is suitable equipped for the application.
Detailed description of the model name, see → p. 169, §9.6.
- ▶ Enter a device name: The device name is freely selectable.
- ▶ The GPS coordinates of the gas flow meter can also be entered as an option.
This allows showing the location of the gas flow meter on Google maps:

Fig. 41 Example: Gas flow meter location

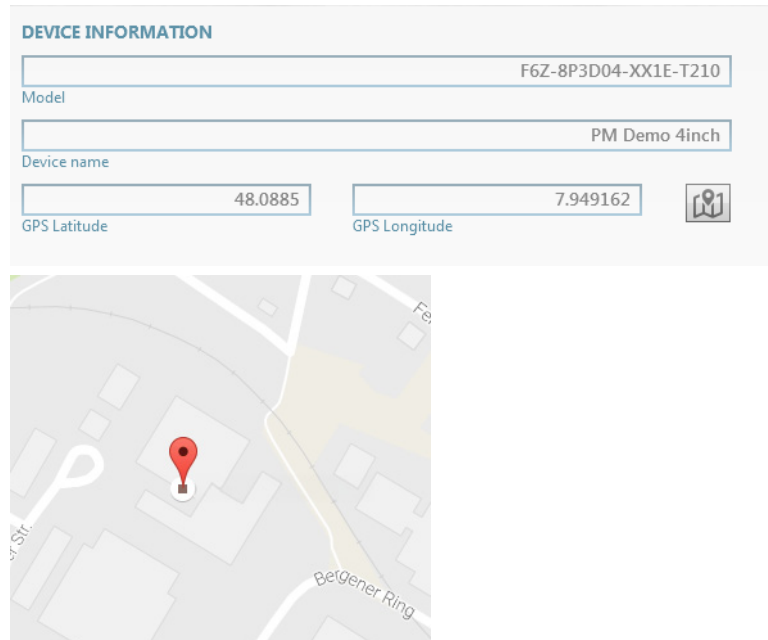

4.3.2.2 System/User

Date and time

- ▶ Enter the date and time or synchronize with the PC.

Units

The units are set at the factory as ordered.

- ▶ Check the settings and adapt when necessary.

Display

The display is preconfigured at the factory.

- ▶ Check the settings and adapt when necessary.

User management

User management is only visible when you are logged in as "Admin".

 **NOTICE:**
Endress+Hauser recommends changing the initial password provided for the administrator for security reasons.

 Please refer to the delivery documentation for the device-specific administrator password.
Otherwise the standard password for the Administrator is valid: 3333

Further users can be created here when desired:

- ▶ Enter a user name.
 - ▶ Specify a password. The password must comprise 4 digits.
 - ▶ Activate the associated checkbox.
- Up to three users and authorized users can be created.
For access rights for single user levels, see → p. 30, Access rights.

Fig. 42

Example: New users

USER MANAGEMENT			
User	Activate	User Name	Password
User 1	<input checked="" type="checkbox"/>	Employee1	••••
User 2	<input type="checkbox"/>		•
User 3	<input type="checkbox"/>		•
Authorized User 1	<input checked="" type="checkbox"/>	Employee2	••••
Authorized User 2	<input type="checkbox"/>		•

4.3.2.3 I/O configuration

The input and output parameters are preset according to the ordered configuration.

+i

- The configuration of the RS485.1 interface at the factory is performed for trouble-free communication on test benches as follows:
 - Protocol type: MODBUS-RTU
 - Modbus configuration: FL600XT (standard)
 - Baud rate: 38,400 baud
 - Bit protocol: 8N1
- When an interface is configured with DSFG instance F, the parameters are set according to the DSFG specification as follows:
 - Protocol type: MODBUS-RTU
 - Modbus configuration: DSFG¹
 - Baud rate: 9,600 baud
 - Bit protocol: 8E1

[1] DSFG Instance F is correctly implemented according to ISO17089-1:2019 Appendix F and supports the register values listed here.

- ▶ Check the parameters and adapt when necessary, e.g. setting the correct Modbus addresses.

Fig. 43 I/O configuration

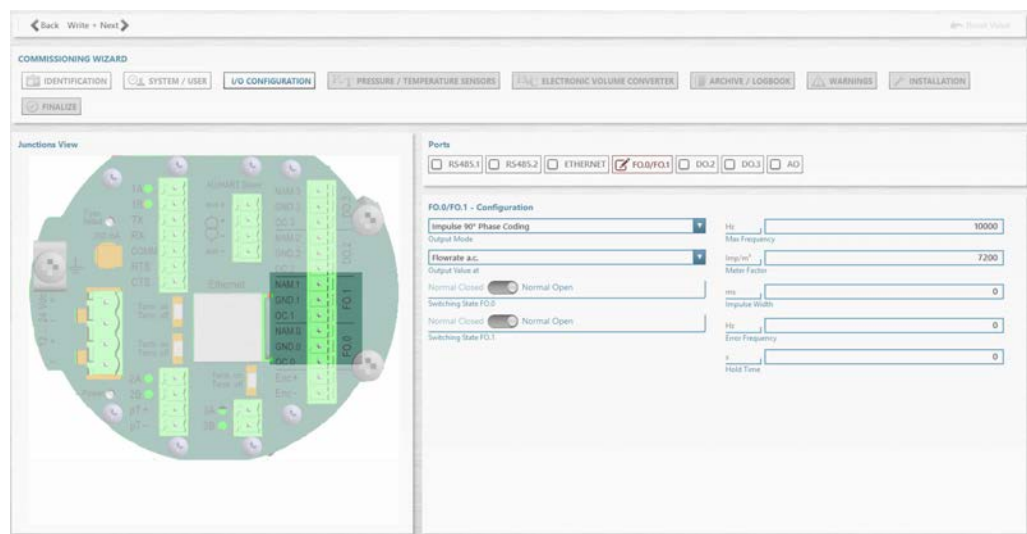

+i The interface marked on the right is always shown highlighted on the left of the Figure. Clicking on the Figure selects the corresponding interface on the right.

A fixed frequency can be stored in field “Error Frequency” which is output if there is a fault. This value is stored in Register #4014 “Impuls_ErrorFrequency” of the meter. The function is deactivated when value 0 is stored. A time interval can be specified in the “Hold time” field in which the measured value is held at the last valid value when the status changes from measurement valid to measurement invalid. This value is stored in Register #4015 “Impulse_HoldTime” of the meter. The function can be used, for example, to bridge short-term disturbances for control purposes.

- 4.3.2.4 **P + T pressure and temperature sensor**
 - ▶ Check the source as well as the default and fixed values for pressure and temperature. The values are preset for high-pressure calibrated devices.
 - ▶ For non-calibrated devices, enter the default and fixed values for pressure and temperature corresponding to the average values expected on the device for operating pressure and operating temperature.

- 4.3.2.5 **Volume converters (optional, only for devices with the volume conversion device option)**
 - ▶ Select the parameters for the calculation.
 - ▶ Enter the specifications for gas characteristics.
 - ▶ Select the algorithm for calculating the compressibility factor.

4.3.2.6 **Archives/Logbooks**

Logbooks

- ▶ Configure how the logbooks function:
 - Stop: A warning is output when the logbook is full.
 - Rolling: The oldest entries are overwritten when the logbook is full.

Data archive 1 and data archive 2

The standard archive configuration records data archive 1 hourly and data archive 2 daily in forward flow direction. Recording periods and recording directions as well as the totalizer to be recorded can be configured:

- Log cycle: Recording period
- Direction: Recording direction
 - The setting for totalizer 1 is used for totalizer 2 when the recording direction is set to “bidirectional”. This means totalizer 1 records in forward direction and totalizer 2 in backward direction.
- Data record type 1: Totalizer 1
- Data record type 2: Totalizer 2

Archive data structure, see → p. 39, §2.10.2.

4.3.2.7 **Diagnostics/warnings**

The standard limits for natural gas applications are set at the factory.

- ▶ Activate single warnings as desired:

Fig. 44 Example: System warnings

SYSTEM / PROFILE		PATH WARNINGS		
System Warnungen	Unit	User Limit	Live Value	Active
● Theoretical SOS Deviation	%	0.3	0.028	<input checked="" type="checkbox"/>
● VOG Limit	m/s	45	0	<input checked="" type="checkbox"/>
● Input Voltage Warning	V	14	10.7	<input type="checkbox"/>
● Configuration Mode				<input type="checkbox"/>
● Unacknowledged Entries				<input type="checkbox"/>
● Full of Unack. Entries				<input type="checkbox"/>

 Endress+Hauser recommends adapting the limit values to the application conditions after several weeks of measuring operation.

4.3.2.8 **Meter installation**

Specifications on the installation conditions of the gas flow meter are relevant for troubleshooting with i-diagnostics™.

The arrow symbol on the gas flow meter shown identifies the primary flow direction.

Fig. 45 Installation conditions (example)

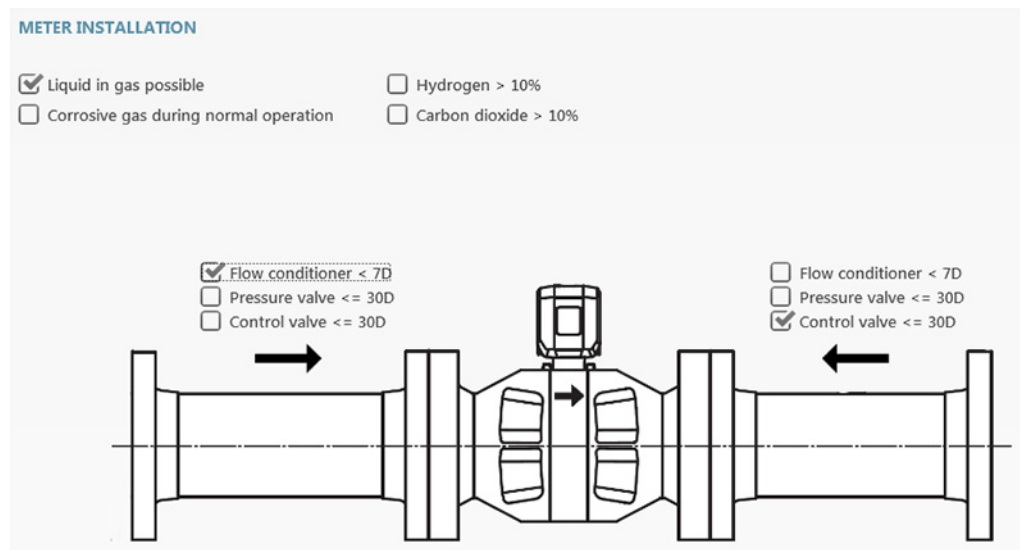

4.3.2.9 **Completion**

- First write the data to the device.

NOTICE: The data must be written to the device before the report is created otherwise the reports are created using the data from commissioning.

- If desired; Reset the malfunction volume encoder totalizer and clear the logbooks.
- Endress+Hauser recommends creating a Parameter report and a Maintenance report and archiving the reports with the delivery documentation, → p. 105, §5.2.4.

4.4 **Function check after commissioning**

4.4.1 **Recommended checks:**

- Checking the meter state, → p. 100, §5.2.1.
- Checking the signal acceptance rate, → p. 96, §4.4.2.
- Zero phase check, → p. 96, §4.4.3.
- Checking the speed of sound, → p. 97, §4.4.4.
- Comparing theoretical and measured sound velocity (SOS), → p. 102, §5.2.2.

4.4.2 **Checking the signal acceptance rate**

- ▶ When the equipment is in operation and a flow rate is available, open the tile “Meter values” in menu “Diagnostics” in the FLOWgate™ operating software.
- ▶ Check the signal acceptance rate (Sign. Acceptance Rate). The signal acceptance rate should be at least 75% on all paths. The signal acceptance rate may be significantly lower when the velocity of gas is above 30 m/s (100 ft/s).

4.4.3 **Zero phase check**

- ▶ Open the tile “Signal View” tile in the “Diagnostics” menu.
- ▶ Check the parameter “Phase shift” for each path (1-1, 1-2, 1-3, 1-4 and 2-1, 2-2, 2-3, 2-4).

Properly adjusted zero phases of the individual paths are the basis for accurate measurement of the ultrasonic signals’ transit time. The “Phase shift” parameter of a path is properly adjusted when the values are lower than 0.2. An adjustment coordinated with Endress+Hauser Service is recommended when the zero phases do not meet the specified criteria.

Fig. 46 Zero phase check

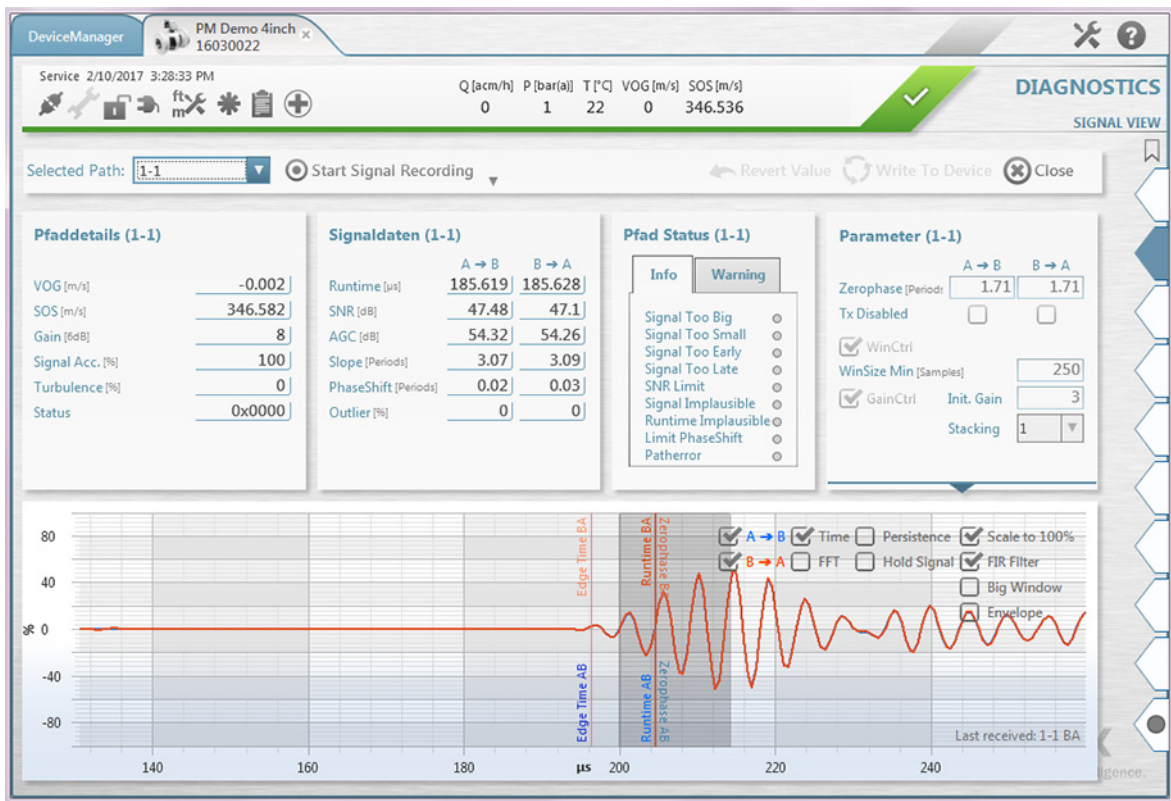

4.4.4

Checking the speed of sound

- ▶ Open the tile “Meter values” in the “Diagnostics” menu.
- ▶ Check the speed of sound (SOS).
- ▶ The speed of sound values must be almost identical on all paths of the FLOWSIC600-XT and may only differ by less than 0.1%.
- ▶ When moving the mouse over the bar graphs, the current measured values are shown in the diagram.

Fig. 47

Speed of sound

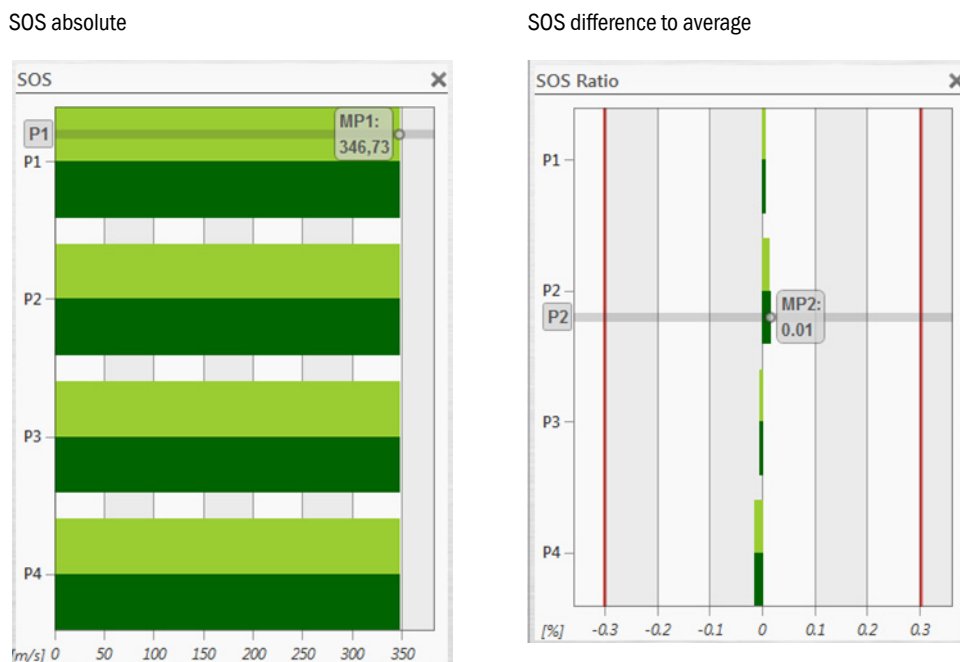

In the case of very low gas velocities (< 1 m/s or 3 ft/s), there may be more significant differences between the sound velocities of the paths due to thermal stratification. In this case, larger differences between the paths can also occur.

Ensure the measured SOS deviates no more than 0.3% from a theoretical SOS which is calculated from gas composition, pressure and temperature → p. 102, §5.2.2 “Comparing theoretical and measured sound velocity (SOS)”.

Further diagnostics values, e.g. velocity of gas (VOG), signal amplification (AGC), signal-to-noise ratio (SNR), turbulence, symmetry and swirl are shown in the “Diagnostics / Meter values” menu.

4.4.5 **Path failure compensation**

The FLOWSIC600-XT can compensate failed measuring paths. A path is considered failed when its acceptance rate is below a certain limit. It is then no longer used to create measured values, but is substituted by a configured or taught relation to the overall speed. It is included in measurement when its acceptance rate is over the limit again.

Path compensation is always active by default. No adaptation is required within the scope of the commissioning.

In a 4-path system, the gas flow meter compensates for a failed measuring path and gives a warning in case of failure. The measurement is still valid under legal metrology. If two or more measuring paths fail, the measurement is invalid, the meter issues a corresponding warning and increments the disturbance volume.

In an 8-path system, the gas flow meter compensates for a failed measuring path per measuring plane and gives a warning in case of failure. According to this, two measuring paths can fail, as long as they are not in the same measuring plane. If two or more measuring paths per measuring plane fail, the measurement is invalid, the meter issues a corresponding warning and increments the disturbance volume.

4.5 **Sealing**

After having completed the commissioning, seal the Signal Processing Unit (if required) in accordance with the sealing plan (→ p. 41, §2.11).

FLOWSIC600-XT

5 Maintenance

General information

Routine checks

Exchanging the battery

Cleaning the FLOWSIC600-XT

5.1 **General information**

The FLOWSIC600-XT does not include mechanical moving parts. The meter body and ultrasonic transducers are the only components that come into contact with the gaseous media. Titanium and high-quality steel ensure that these components are resistant to corrosion, provided that the meter is installed and operated in accordance with the relevant specifications.

This means that the FLOWSIC600-XT is a low-maintenance system.

User Warning Limits can be configured to provide early warnings for possible issues with contamination. Maintenance is limited mainly to routine checks to determine the plausibility of the measured values and diagnostic results produced by the system.

Endress+Hauser recommends that Maintenance Reports be created and filed on a regular basis (→ p. 105, §5.2.4). Over a period of time, this provides a comparison data base useful when diagnosing problems.

 The operating conditions (gas composition, pressure, temperature, flow velocity) of the individual Maintenance Reports should be similar. When the individual reports are compared, it is recommended to evaluate and document deviations.

5.2 **Routine checks**

Proper device function can be determined directly on the front panel of the FLOWSIC600-XT. The FLOWgate™ operating software provides a user-friendly option for the performance of routine checks (connect to the device, → p. 90, §4.3.1).

5.2.1 **Checking the meter state**



The FLOWSIC600-XT checks its own meter state with a system of user warnings and alarms. If the I/O interfaces are configured to indicate alarms and/or user warnings, it is not necessary to manually check the meter state.

The system status in the FLOWgate™ operating software provides a general overview when a visual feedback on the meter's state is desired.

5.2.1.1 **Function check on the display**

If there is a warning or malfunction on the device, the corresponding symbol is shown in the Signal Processing Unit display.

Table 14 Symbols

Symbol	Significance	Description
	Device status: Malfunction	The device has an error, the measured value is invalid.
	Device status: Warning	The device has a warning, the measured value is still valid.
	Registered events	Events have occurred since the last event summary reset.



- ▶ An active error or warning is shown flashing in the LC display. Current errors or warnings can be retrieved under “Device status” / “Current events” with error code; status messages see → p. 120, § 7.1.
- ▶ The status output can be configured to show whether the meter state “Measurement valid”, “Warning”, “Error”, “Maintenance necessary”, “Backward flow” or status “Configuration mode” becomes active.

- ▶ The FLOWgate™ operating software can be used to test the meter state. System alarms and User Warnings are indicated in the Status bar.
It is recommended to use the FLOWgate™ operating software to obtain further information on the meter’s state.

5.2.1.2 **Function check with FLOWgate™**

- ▶ Check the device status.

Table 15 Signaling the device status in FLOWgate™

Status	Description
	Normal operation, neither warnings nor errors exist
	Device status warning: At least one warning is pending in the device, the measured value is still valid.
	Device status error: At least one error is pending in the device, the measured value is invalid.

- ▶ Click on the symbol in the Status bar when warnings or errors exist.
The current Status overview opens and shows details and information on how to proceed.

Fig. 48

Current status

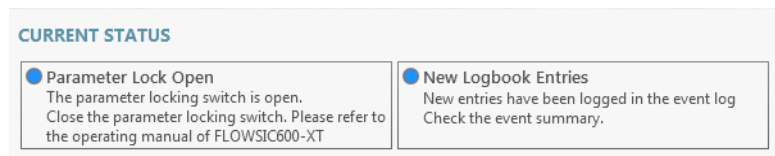

The “Diagnostics” menu shows under “Meter values” in various profiles all diagnostics values providing information on the status of the device.

Fig. 49 Meter values

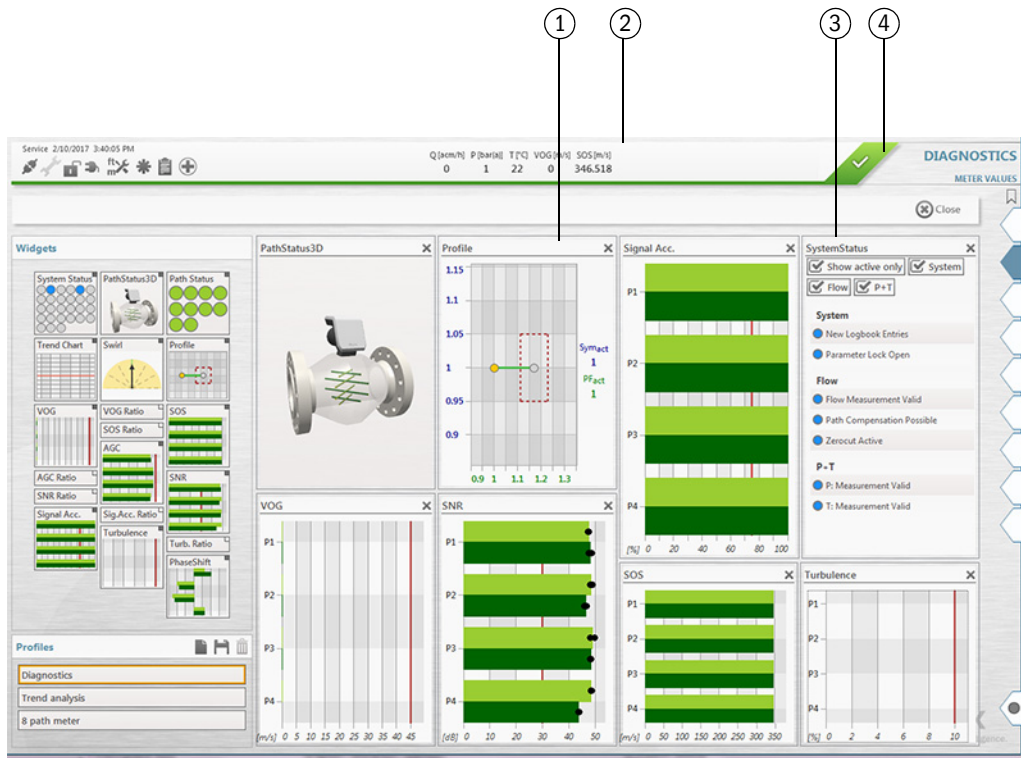

- 1 Diagnostic information
- 2 Measured SOS
- 3 System status
- 4 Status bar

5.2.2 **Comparing theoretical and measured sound velocity (SOS)**

One of the main criteria for correct operation of an ultrasonic gas flow meter is conformity between the theoretical sound velocity calculated for the actual gas composition, temperature and pressure, and the sound velocity measured by the ultrasonic gas flow meter.

The Speed of Sound Calculator (SOS Calculator) available in the FLOWgate™ operating software calculates a theoretical SOS for a specific gas composition at a specified temperature and pressure (→ Fig. 50). The calculation of thermodynamic properties is based optionally on the “GERG-2008” or “AGA10” algorithm.

- 1 Connect FLOWSIC600-XT and FLOWgate™, → p. 90, § 4.3.1.
- 2 Open “SOS Calculator” in the “Diagnostics” menu.
- 3 Select the gas composition and confirm with “Apply”. The gas composition can be entered manually or loaded as file.
- 4 Enter the current process conditions and select “Calculate SOS”.

Fig. 50 SOS Calculator

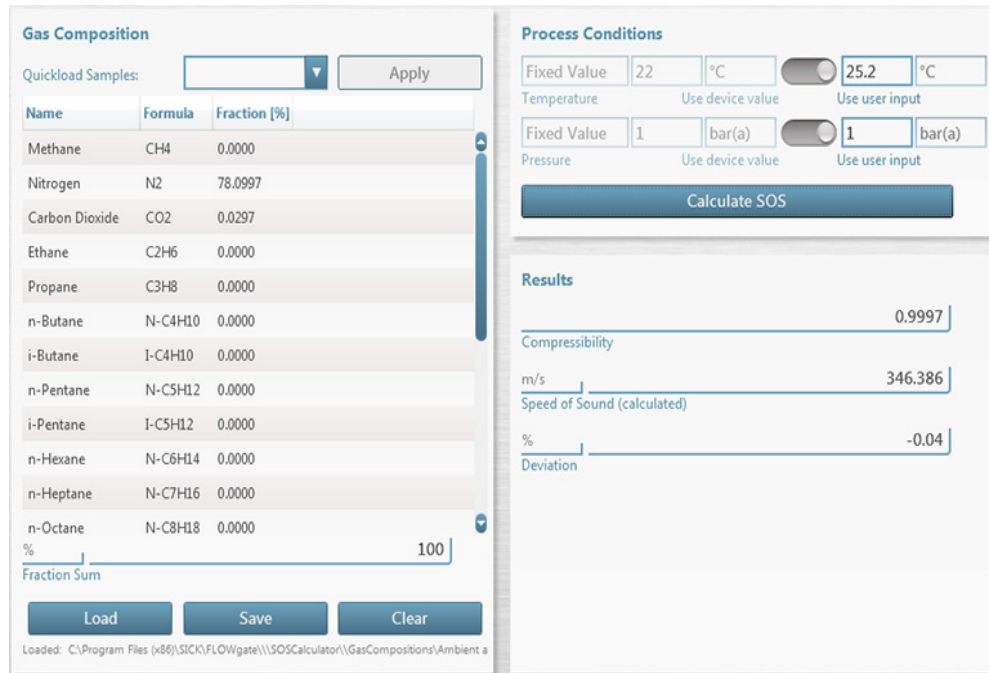

- 5 Compare the theoretical speed of sound with the speed of sound measured with the FLOWSIC600-XT.
The deviation of the measured SOS from the calculated SOS is shown for each path in the “Deviations per Path” area, → Fig. 51.

Fig. 51 Speed of sound (SOS)

Deviations Per Path			
Path	SOS meas. [m/s]	SOS calc. [m/s]	Deviation [%]
Global	346.532	346.39	-0.04 %
1-1	346.552	346.39	-0.05 %
1-2	346.495	346.39	-0.03 %
1-3	346.493	346.39	-0.03 %
1-4	346.585	346.39	-0.06 %
2-1	346.573	346.39	-0.05 %
2-2	346.489	346.39	-0.03 %
2-3	346.516	346.39	-0.04 %
2-4	346.557	346.39	-0.05 %

- 6 The deviation between the two speeds of sound should be less than $\pm 0.1\%$.
If the deviation exceeds 0.3%: Check the plausibility of the pressure, temperature and gas composition values.

5.2.3 **Time synchronization**

5.2.3.1 **Time synchronization via Modbus**

The FLOWsic600-XT has a real-time clock which continues to run also in the case of a power failure. The real-time clock has a separate battery (BR2032). The time is saved as UNIX Timestamp (UTC) in the device and in the stored data records. The UNIX Timestamp specifies the number of seconds since 01.01.1970 with leap year correction.

The UNIX Timestamp can be read and set directly via register #4304 "RTC_Timestamp". Writing to the RTC_Timestamp sets the internal clock and is documented with an entry in the event logbook. All external synchronizations (for example with PC time) should be performed with this RTC_Timestamp as UTC.

The device can also return the local time. 3 registers exist for this purpose: Time (#4302 "RTC_Time"), date (#4300 "RTC_Date") and time zone (#4306 "RTC_Timezone"). A read access always returns the current local time.

Write access to time or date crates an entry in the event logbook each time. Setting the time zone does not cause an entry in the event logbook because only the representation of the local time changes, but not the UTC.

A regional adaptation of the local time representation can be performed via register #4102 "LCD_DateTimeFormat". The European 24 h format as well as the American 24 h format and the American 12 h format are supported.

5.2.3.2 **Time synchronization with the FLOWgate™ operating software**

Date and time can be synchronized In the FLOWgate™ operating software with the connected PC during commissioning or in menu "Parameter Modification" and "System/User".

Fig. 52 Time synchronization

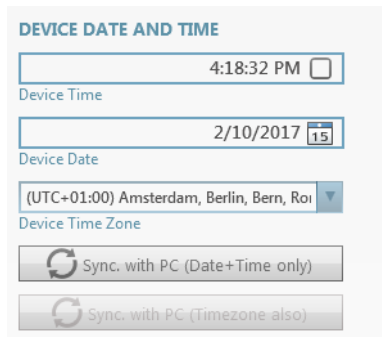

5.2.3.3 **Service life/capacity of RTC battery**

The real-time clock (RTC) of FLOWsic600-XT is buffered by a battery. The device checks permanently whether the real-time clock is working and date and time have valid values. If this is not the case, a device error occurs and results in the respective entry in the event logbook. The error is eliminated only when a valid date is set.

In addition, the voltage of the RTC battery is permanently monitored. If the battery voltage drops below 1.8 V, maintenance request (low battery voltage) is signaled. If the battery voltage rises above 2.2 V, the maintenance request is reset. If the battery voltage drops below 1.2 V, maintenance request (no battery available) is also signaled. A low voltage level or a battery failure also results in an entry in the event logbook. Information on battery change, see → p. 109, §5.3.

5.2.4 **Maintenance report**

It is advisable to regularly create and archive a Maintenance report. This serves to create a comparison database and supports diagnostics.

+i The operating conditions (gas composition, pressure, temperature, flow velocity) of the individual Maintenance Reports should be similar. When the individual reports are compared, it is recommended to evaluate and document deviations.

- 1 Click  in the status bar.
- 2 The “Maintenance Report” dialog opens.
It is recommended to set the duration of data collection to 5 minutes, but it can also be changed in the selection list.

Fig. 53 Maintenance report



Maintenance Report

Report Name

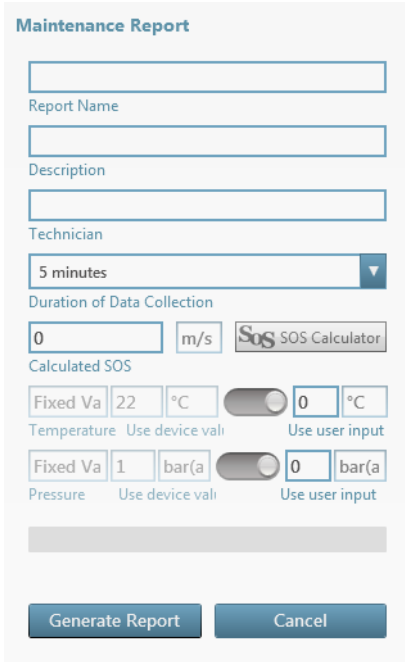
Description

Technician

5 minutes

Duration of Data Collection

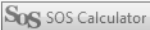
0 m/s 

Calculated SOS

Fixed Va 22 °C 0 °C

Temperature Use device val Use user input

Fixed Va 1 bar(a) 0 bar(a)

Pressure Use device val Use user input

Generate Report Cancel

- 3 After the end of data collection, the report opens automatically and can be printed, saved as PDF document or sent via e-mail.
- 4 Finally close the report with the “Close” button.
- 5 It is recommended to file the printed report with the device delivery documentation.

5.2.5 **Optional data backup**

 To prevent an overflow of the logbooks and possible data loss, logbook entries can be saved to the meter database with the FLOWgate™ operating software. The entries on the meter can then be deleted.

5.2.5.1 **Logbook check and data backup**

Page “Logbook Management” provides an overview and a general introduction to the logbooks.

The following functions are available here:

- “Load all logbooks from device”: Load the complete contents of all logbooks in the PC database.
- “Load all logbooks from database”: Add the overview data that are already on the PC to the logbook and make them available during the FLOWgate™ session.
- “Clear All Logbooks”: When the logbooks have been loaded from the device, they can be deleted in the device.
- When a logbook is selected, it is possible to only load/delete this logbook or to export it to CSV format or as PDF report.

The PDF report is automatically opened and can be printed, saved or sent via e-mail.

Fig. 54 Example: Event logbook

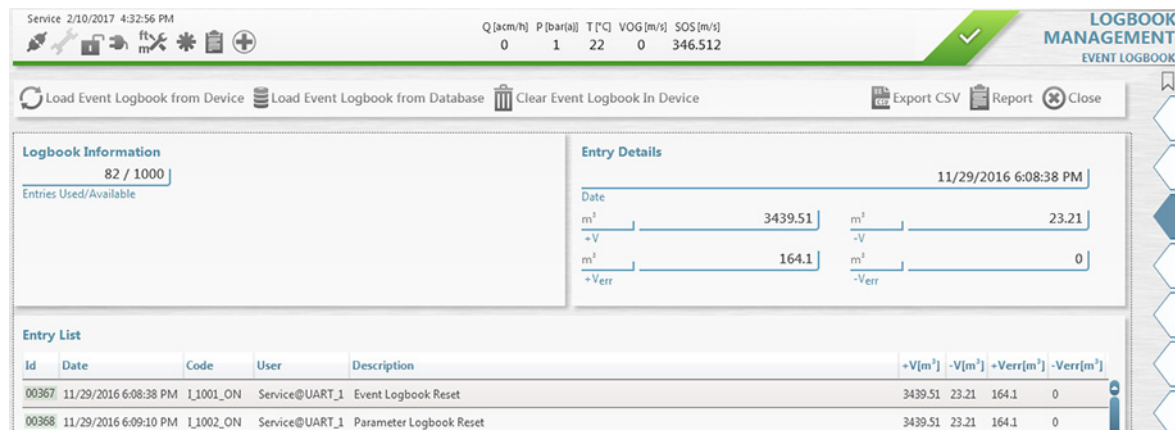

Deleting logbook entries

Logbook entries can be deleted only via the FLOWgate™ operating software with button “Clear all Logbooks”. Deleting the entries in FLOWgate™ is not possible.

5.2.5.2 **Checking the data archives (data logs)**

FLOWSIC600-XT has a diagnostics archive and two data archives:

- Data archive 1 (Hourly Log) on an hourly basis
- Data archive 2 (Daily Log) on a daily basis

The measured data archives are saved accordingly in the non-volatile memory of the device.

All data archives can be loaded and read in the “Archive Management” overview. In the individual archives, each archive can be loaded individually from the device to the PC.

The archive data can be exported in CFX or CSV Format and then stored or sent as e-mail.

Fig. 55 Example: Data archive 1

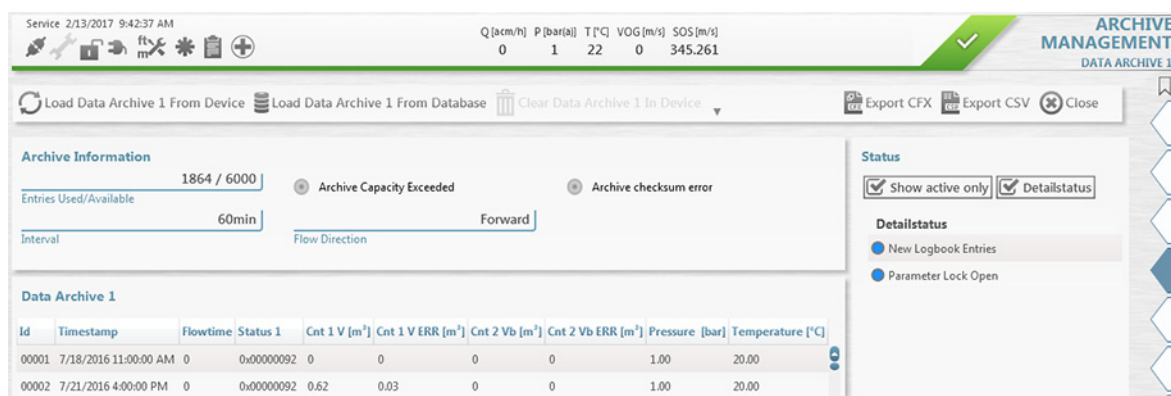

Deleting the data archives

The data archives can be deleted via the FLOWgate™ operating software. In the archive overview of the “Archive Management”, all data archives can be deleted at once or each individually directly in the respective archive.

5.2.6 **Creating and evaluating the Diagnostics Comparison report**

FLOWgate supports the creation of a Diagnostics Comparison report. This visualizes a comparison of the most important current process and diagnostic data with the fingerprint data stored in the device during commissioning. The data is displayed for the individual speed classes.

The report can be created at any time and stored as a PDF document. This enables, for example, trend reporting over the lifetime of the meter with which process or meter changes can be detected.

Fig. 56 FLOWgate™ Diagnostics archive

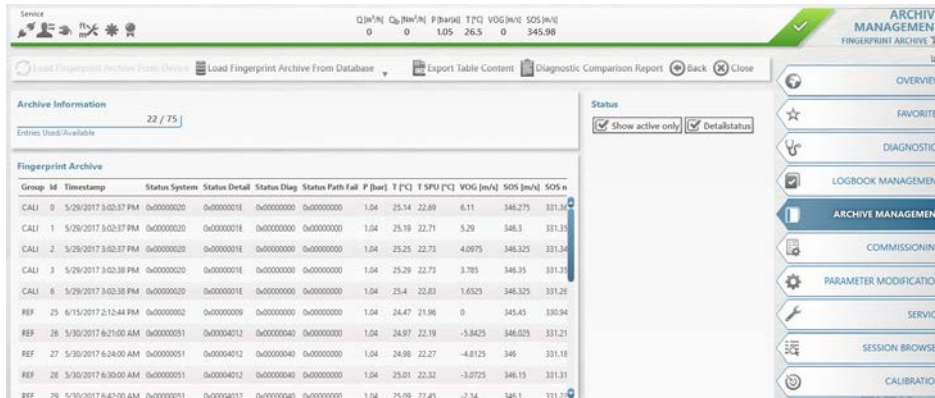

Creating the report

- ▶ Select “ARCHIVE MANAGEMENT” in the menu
- ▶ Select the “FINGERPRINT” tile
- ▶ Select “Load Fingerprint Archive from Device” to load the current process data from FLOWsIC600-XT into the FLOWgate database. This process may take a few seconds depending on the amount of data. The data is displayed in tabular form in the “Fingerprint Archive”.
- ▶ Then select “Diagnostic Comparison Report” in the upper right corner of the menu bar. In the query window that opens, select whether the report should be generated for the forward or reverse direction of the gas flow. You also have the option of entering the name of the person who created the report. This is displayed in the report.
- ▶ After confirming with “OK”, the report is created and can be sent by e-mail or saved as a PDF document by clicking the “Send/Save” button.

Fig. 57 Example of a Diagnostic report

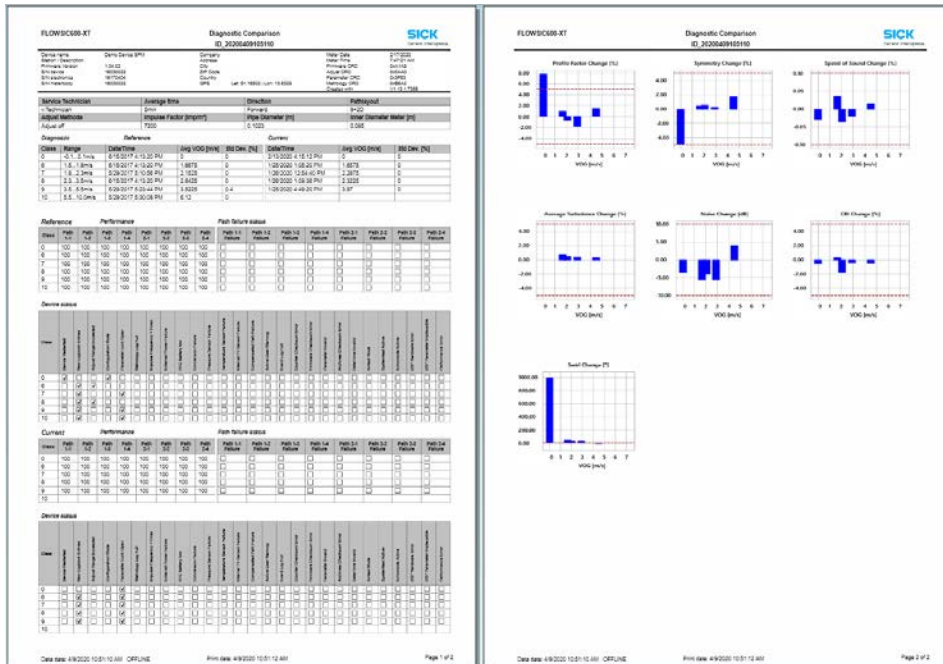

5.3 **Exchanging the battery**

5.3.1 **Battery types**

	<p>NOTICE:</p> <p>The exchangeable backup battery and its electric connections are rated as intrinsically safe according to IEC/EN 60079-11:2011.</p> <ul style="list-style-type: none"> ▶ The backup battery may also be used in the non-intrinsically safe FLOWSIC600-XT versions whereby the exchange can also be made in the danger area.
---	---



- Only PANASONIC batteries type BR2032 are permitted as the RTC battery otherwise the intrinsic safety is endangered.
- Only replace the backup battery with a similar type from Endress+Hauser with item number 2079721 otherwise the intrinsic safety is endangered.

5.3.2 **Information on handling lithium batteries**

	<p>WARNING: Risk of explosion - hazard for intrinsic safety</p> <ul style="list-style-type: none"> ▶ Only the exchangeable battery packs from Endress+Hauser may be used! ▶ Do not use damaged batteries; these must be disposed of correctly!
---	---

The battery packs are marked with important information concerning storage and disposal.

Table 16 Marking

Symbol	Significance
	Do not dispose with household trash.
	Recycling

5.3.2.1 **Information on storage and transport**

- ▶ Prevent a short circuit of the battery terminals:
 - Store and transport the batteries in their original packaging
 - or tape the battery terminals.
- ▶ Store cool (under 21 °C (70 °F)), dry and without major temperature fluctuations.
- ▶ Protect against permanent sunlight.
- ▶ Do not store near the heating.

5.3.2.2 **Disposal information**

In the EU

- ▶ Dispose of lithium batteries in accordance with Battery Directive 2006/66/EU.
- ▶ In Germany, you can hand in the batteries at your local recycling center. Alternatively, the battery manufacturer Tadiran Germany offers a return service on request.

Contact data:

Phone: +49 (0)6042/954-122

Fax: +49 (0)6042/954-190

www.tadiranbatteries.de

In the USA

- ▶ Batteries have to be disposed of by an authorized waste disposal company.
Identification of lithium batteries:
 - Proper shipping name: Waste lithium batteries
 - UN number: 3090
 - Label requirements: MISCELLANEOUS, HAZARDOUS WASTE
 - Disposal code: D003
- ▶ If anything is unclear, contact the local office of the Environmental Protection Agency (EPA).

In other countries:

Please observe national regulations for the disposal of lithium batteries.

5.3.3 **Replacing the backup battery**

5.3.3.1 **Swivel the display unit downwards**

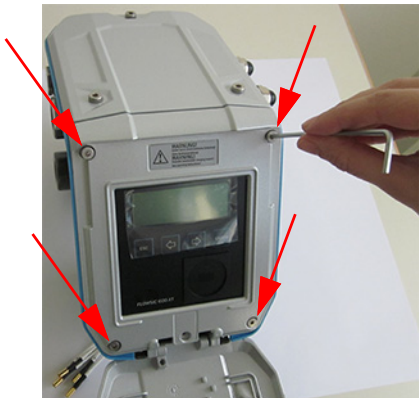
<p>1 Loosen the screw on the display protective flap with an SW3 Allen key.</p>	
<p>2 Swivel down the display protective flap.</p>	
<p>3 Loosen the 4 screws on the display unit with an SW4 Allen key.</p>	
<p>4 Carefully swivel the display unit downwards.</p>	

5.3.3.2 Remove the backup battery

- 1 Make sure the external power supply is active.
- 2 Disconnect the backup battery connection.
- 3 Take the backup battery out of the holder.

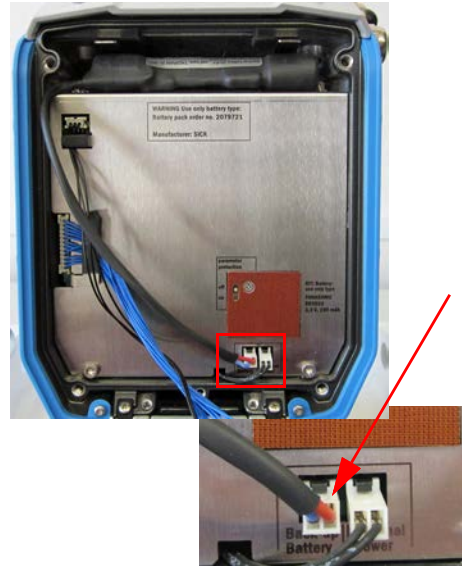

5.3.3.3 Insert the new backup battery

- 1 Unpack the new backup battery and check for transport damage.
- 2 Do not use the backup battery when any damage can be seen.
- 3 Make sure the external power supply is active before connecting the backup battery. Otherwise the backup battery is immediately active.
- 4 Insert the backup battery in the holder and connect to the "Backup Battery" connection.

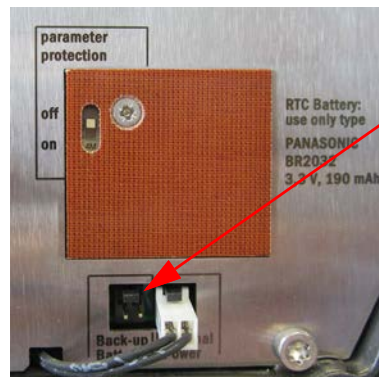

5.3.3.4 **Swivel the display unit upwards and lock**

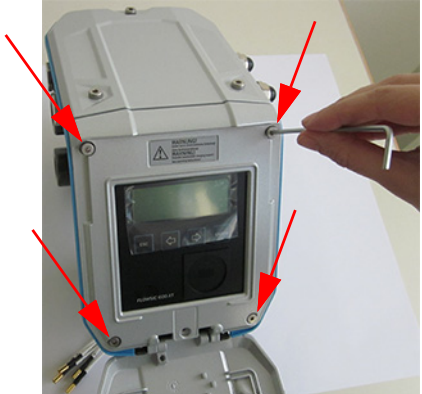
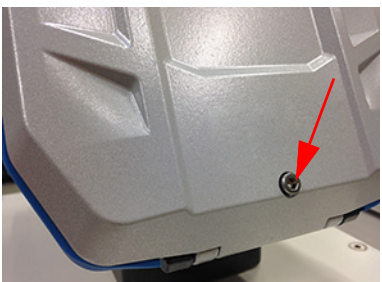
<ol style="list-style-type: none"> 1 Ensure the sealing area is free from contamination. 2 Swivel the display unit upwards. 3 Tighten the 4 screws on the display unit hand tight (5 Nm) with an SW 4 Allen key. 	
<ol style="list-style-type: none"> 4 Close the display protective flap. 5 Tighten the screw on the display protective flap with an SW3 Allen key. 	

5.3.4 **Replacing the RTC battery**

Prerequisites

- ▶ The display unit is swiveled down:
 - Swivel the display unit downwards, → p. 111, §5.3.3.1.
- ▶ To replace the RTC battery, the metrology seal on the parameter locking switch must be opened, if present.

	<p>NOTICE: Measures in a metrologically secured area</p> <ul style="list-style-type: none"> ▶ If stipulated by national regulations, measures on the device in the metrologically secured area after commissioning may be carried out only under official supervision. ▶ This must be coordinated with the authorities before carrying out the measures. ▶ All actions must be performed on the basis of this Manual and, if necessary, the Service Manual for the product.
---	---

Replacing the RTC battery

- 1 Remove the adhesive label on the battery cover, if present.
- 2 Loosen the screw fitting of the battery cover with a Phillips screwdriver.
- 3 Remove the battery cover.



- 4 Use a small slot screwdriver to carefully lever the RTC battery out of the holder.



- 5 Insert the new RTC battery.

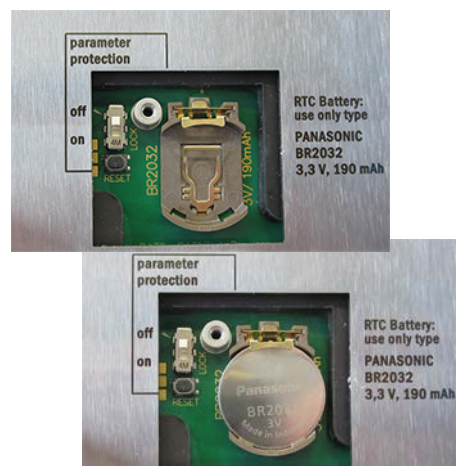

- 6 Refit the battery cover.
- 7 If necessary, have a new seal attached to the battery cover.
- 8 Swivel the display unit back up and screw tight, → p. 113, §5.3.3.4.
- 9 Connect with the device using the FLOWgate™ operating software, → p. 90, §4.3.1.
- 10 Open the System/User tile in the Parameter Modification menu.
- 11 Set the date and time or synchronize with the PC.

5.4

Cleaning the FLOWSIC600-XT



WARNING: Ignition hazard through electrostatic discharges

- ▶ The plastic display surface exceeds the allowable value for ignition group IIC. The user must take suitable precautionary measures to eliminate the risk of ignition through electrostatic discharges.
- ▶ The paint coat thickness on the surfaces accessible from the outside exceeds the allowable thickness for ignition group IIC. The user must take suitable precautionary measures to eliminate the risk of ignition through electrostatic discharges.



NOTICE:

Please observe the specific conditions of use in potentially explosive atmospheres, → p. 14, § 1.3.3.

- ▶ Only use cleaning agents free from oil, grease and solvents to clean the display.
- ▶ Use a damp cloth for cleaning.

FLWSIC600-XT

6 Shutting down

Returning
Disposal information

6.1 **Returning**

6.1.1 **Contact**

Please contact your Endress+Hauser representative for assistance.

6.1.2 **Packing**

Make sure the FLOWSIC600-XT cannot be damaged during transport.

**NOTICE:**

Remove the backup battery before shipping the FLOWSIC600-XT, → p. 111, §5.3.3.

6.2 **Disposal information**

6.2.1 **Materials**

The FLOWSIC600-XT mainly consists of steel, aluminium and plastic materials. It does not contain any poisonous, radioactive or environmentally hazardous substances. Substances from the pipeline could possibly penetrate the seals or deposit on these.

6.2.2 **Disposal**

- ▶ Dispose of electronic components as electronic waste.
- ▶ Check which materials having contact with the pipeline must be disposed of as hazardous waste.
- ▶ Dispose of batteries in accordance with → p. 109, §5.3.2.2.

FLOWSIC600-XT

7 Troubleshooting

Status messages
Starting a diagnostic session

7.1 **Status messages**

- Active errors or warnings are shown flashing in the LC display. Current errors or warnings can be retrieved under “Device status” / “Current events” with error code.
- Detailed information on the status messages is available via the FLOWgate™ operating software in the Diagnostics menu via the “Status Diagnostics” tile.

 ► Contact Endress+Hauser Customer Service for any malfunctions you cannot clear yourself.

► To help Customer Service to understand malfunctions that have occurred, the FLOWgate™ operating software provides the option to create a diagnostics file that can be sent to Customer Service, → p. 121, § 7.2.

Table 17 Status messages

Category	No.	Description
INF	1016	Restart device
INF	1017	New entries in Event logbook
INF	1018	Adjustment limits exceeded
INF	1019	Configuration mode
INF	1020	Parameter lock open
INF	1021	Air test mode
INF	1022	Metrology logbook full
WRN	2001	Impulse frequency > fmax
WRN	2002	Ext. supply failed
WRN	2003	RTC battery empty
WRN	2004	Backup restore failed
WRN	2005	Pressure sensor failed
WRN	2006	Temperature sensor failed
WRN	2007	Internal PT sensor failed
WRN	2008	Warning path failure
WRN	2009	Flow profile limit exceeded
WRN	2010	System warning threshold exceeded
WRN	2011	Trend limit exceeded
ERR	3001	Event logbook full
ERR	3002	Totalizer checksum error
ERR	3003	Firmware checksum error
ERR	3004	Parameter invalid
ERR	3005	Archive checksum error
ERR	3006	Time invalid
ERR	3007	System test active
ERR	3008	Run-time measurement mode
ERR	3009	DSP hardware failed
ERR	3010	DSP parameter invalid
ERR	3011	Error path failure

7.2 **Starting a diagnostic session**

- 1 Click the  icon in the tool bar to start a diagnostic session.
- 2 Select the desired data collection time.
It is recommended to select a minimum data collection time of 5 minutes and to load the logbooks and data archives

Fig. 58 Data collection time for the diagnostic session



- 3 Click "Start" to start recording.
The following message with the current storage location of the data collection is shown after successful creation of the diagnostic session.

Fig. 59 Diagnostic recording completed

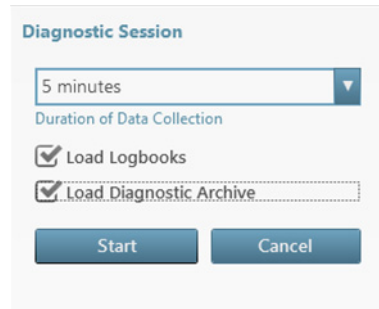
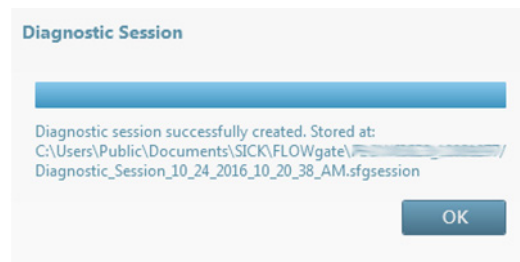

- 4 Click "OK" to confirm the message.
 - Click "Save as" to select a storage location for the diagnostic recording.
 - Click "E-mail" to send the file per e-mail. The file is appended to an e-mail when an e-mail client is available.
 - Click "Close" to leave the file at the standard storage location.

Fig. 60 Save the diagnostic session



 The diagnostic sessions are saved as files with the ending .sfgsession. The files are saved by default under:
C:\Users\Public\Documents\SICK\FLOWgate
The name of the storage folder consists of device type and serial number of the device.

FLOWSIC600-XT

8 Specifications

- Conformities
- Technical data
- Measuring ranges
- Dimensions

8.1 Conformities

8.1.1 CE certificate

The FLOWSIC600-XT has been developed, manufactured and tested in accordance with the following EU Directives:

- Pressure Equipment Directive 2014/68/EU
- ATEX Directive 2014/34/EU
- EMC Directive 2014/30/EU
- Measuring Instrument Directive 2014/32/EU

Conformity with the above directives has been verified and the device has been marked with the CE label. The special identification of the pressure devices as demanded in accordance with Pressure Device Guideline 2014/68/EC, Parts 3.3 and 3.4, can be found in the Manufacturer Data Report of the FLOWSIC600-XT.

8.1.2 Standards compatibility and type approval

The FLOWSIC600-XT conforms with the following standards or recommendations:

- EN 60079-0:2018, EN 60079-1: 2014, EN 60079-7:2015 + A1:2018, EN 60079-11:2012, EN60079-15:2010,
- EN 60079-26:2021, EN 60079-28:2015, EN 61326-1:2013
- EN 60529: 1991/A1:2000/A2:2013 (IP)
- AGA Report No. 9, 4th Edition 2022 "Measurement of Gas by Multipath Ultrasonic Meters"
- API 21.1 "Flow Measurement Using Electronic Metering Systems"
- BS 7965:2013, "Guide to the selection, installation, operation and calibration of diagonal path transit time ultrasonic flowmeters for industrial gas applications"
- ISO 17089-1:2019 "Measurement of fluid flow in closed conduits - Ultrasonic meters for gas - Part 1: Meters for custody transfer and allocation measurement"
- OIML R 137-1&2 Edition 2012 (E) "Gas meters, Part 1: Metrological and technical requirements, Part 2: Metrological controls and performance tests"
- OIML D 11 Edition 2013 (E) "General requirements for electronic measuring instruments"

The device is designed according to the following type approvals:

- Europe: MID approval, DE-16-MI002-PTB001
- GOST 67355-17 (see FLOWSIC600-XT Addendum to the Operating Instructions "Installation requirements and accuracy of the meter in accordance with Russian type approval")

8.1.3 WELMEC conformity

The FLOWSIC600-XT conforms with:

- WELMEC 7.2 Issue 5, "Software Guide"
- WELMEC 11.1 Issue 4, "Common Application for utility meters"
- WELMEC 11.3 Issue 1, "Guide for sealing of utility meters"

8.2 **Technical data**

The exact device specifications and performance data of the product can deviate and depend on the respective application and customer specification.

 Installation requirements in accordance with GOST, see document “8020847 Installation Requirements GOST”

Table 18 Technical data

Meter characteristics and measuring parameters		
Measured variables	Actual flow rate, volume at flowing conditions, gas velocity, sound velocity, optional volume correction via integrated electronic volume converter (EVC)	
Number of measuring paths	2, 4, 4+1 (2plex), 4+4 (Quatro), 8 (Forte)	
Measuring principle	Ultrasonic transit time difference measurement	
Measured medium	Natural gas, air, natural gases with increased proportions of CO ₂ , N ₂ , H ₂ S, O ₂ , H ₂ ≤ 30Vol%	
Measuring ranges	Q _{min} : 5 ... 750 m ³ /h Q _{max} : 1,000 ... 100,000 m ³ /h Measuring ranges depending on nominal pipe size	
Repeatability	± 0.05% of the measured value (typical), ± 0.1% of the measured value for 2-path version	
Accuracy	Typical error limits Q _t ... Q _{max}	
	4-path- and 8-path versions:	≤ ± 0.5%, dry calibrated (typical) ≤ ± 0.2% After flow calibration and adjustment with constant factor. Without uncertainty of the calibration test facility. ≤ ± 0.1% After flow calibration and adjustment with polynomial or gradual correction. Without uncertainty of the calibration test facility.
	2-path version:	≤ ± 3%, dry calibrated (typical) ≤ ± 0.5% After flow calibration and adjustment. Without uncertainty of the calibration test facility.
Minimum line requirements	4-path version:	
	According to OIML Class 1.0	With straight inlet section ≥ 10D or ≥ 5D with flow conditioner.
	According to OIML Class 0.5	With straight inlet section ≥ 10D and flow conditioner
	8-path version:	
	According to OIML Class 1.0	With straight inlet section ≥ 2D
	According to OIML Class 0.5	With straight inlet section ≥ 5D
2-path version:		
	According to OIML Class 1.5	With straight inlet section ≥ 50D or ≥ 20D with flow conditioner.
Diagnostics functions	i-diagnostics™: Integrated device diagnostics and intelligent advanced device and application diagnostics via the FLOWgate™ operating software	
Gas temperature	-46 °C ... +180 °C (ATEX/IECEX) -46 °C ... +180 °C (CSA) -196 °C ... +230 °C (with remote Signal Processing Unit, on request)	
Operating pressure	0 bar(g) ... 450 bar (g)	
Nominal pipe size	2" ... 56" (DN 50 ... DN 1400)	
Ambient conditions		
Ambient temperature	-40 °C ... +70 °C (-60 °C ... +70 °C with enclosure for electronics)	
Storage temperature	-40 °C ... +70 °C (-60 °C ... +70 °C for the meter body)	
Ambient humidity	≤ 95% relative humidity, non-condensing	
Ambient pressure	0.8 ... 1.1 bar (max. altitude 2000 m)	
Pollution degree	2	

Conformities and Approvals	
Conformities	OIML R 137-1&2:2012 (class 0,5) OIML D 11:2013 ISO 17089-1 AGA Report No. 9 MID: 2014/32/EU PED: 2014/68/EU ASME B16.5, B16.47A/B, B31.3 ATEX: 2014/34/EU EMC 2014/30/EU GOST 8.611-2013 GOST 8.733-2011 CPA: JIG1030-2007 PCEC: GB 3836.1-2010, GB 3836.2-2010, GB 3836.4-2010, GB/T 3836.22-2017
Ex Approvals	IECEX Ex db ia op is [ia Ga] IIA / IIC T4 Gb Ex db eb ia op is [ia Ga] IIA/ IIC T4 Gb Ex ia op is IIA/ IIC T4 Ga
	ATEX II 2 (1) G Ex db ia op is [ia Ga] IIA / IIC T4 Gb II 2 (1) G Ex db eb ia op is [ia Ga] IIA/ IIC T4 Gb II 1G Ex ia op is IIA/ IIC T4 Ga
	NEC/CEC (US/CA) Explosion-proof/non-flammable: CI I, Div. 1 Group D, T4 / Ex db ia [ia Ga] IIA T4 Gb / CI I, Zone 1 AEx db ia op is [ia Ga] IIA T4 Gb CI I, Div. 1 Groups B, C, D, T4 / Ex db ia [ia Ga] IIC T4 Gb / CI I, Zone 1 AEx db ia op is [ia Ga] IIC T4 Gb Intrinsically safe: CI I, Div. 1 Group D T4 / Ex ia IIA T4 Ga / CI I, Zone 0, AEx ia op is IIA T4 Ga CI I, Div. 1 Groups A, B, C, D, T4 / Ex ia IIC T4 Ga / CI I, Zone 0, AEx ia op is IIC T4 Ga
IP classification	IP66 according to ATEX/IECEX/CSA approval IP67 according to IEC60529, with additional Certificate
Outputs and interfaces	
Analog outputs	1 output: 4 ... 20 mA, max. 250 Ω Active/passive, electrically isolated
Digital outputs	4 outputs: ≤ 30 V, 50 mA Passive, electrically isolated, Open Collector or in accordance with NAMUR (DIN EN 60947-5-6), f _{max} = 10 kHz
Interfaces	Optical Service interface (IR, in accordance with IEC 62056-21) RS-485 (3x) Ethernet TCP (1x optional) HART-Master (external pressure and temperature transmitter) Encoder
Bus protocol	Modbus ASCII Modbus RTU Modbus TCP (optional) Register assignments (optional): DSFG, instance F / ISO 17089 FLOWSIC600-compatible Modbus registers
Operation	Via meter display (read access) and the FLOWgate™ operating software

Installation	
Dimensions (W x H x D)	See dimension drawings
Weight	Depending on device version
Material in contact with media	Low-temperature carbon steel, stainless steel, Duplex steel
Electrical connection	
Voltage	Flameproof pressurized electronics variant / electronics variant with terminal compartment in increased type of protection: Electrically isolated: 12 ... 24 V DC, $\pm 10\%$
	Intrinsically safe electronics variant: 6 ... 16 V DC, $\pm 10\%$
	PowerIn Technology™ with backup battery (2,400 mAh, 10.8 V), optional for all electronics variants
	Overvoltage category 1
Power input	Typically 0.45 W ... 2.45 W Dependent on selected electronics configuration
Components fitted (optional)	
Pressure and temperature sensor	Values measured for pressure and temperature are used to correct the meter body geometry and to determine the current Reynolds number.

Table 19 Volume conversion

Conversion method	PTZ (optional integrated)
Calculation method for compressibility	SGERG88 AGA 8 Gross method 1 AGA 8 Gross method 2 AGA NX-19 AGA NX-19 mod. NX-19 mod. (GOST) GERG91 mod. (GOST) Fixed value GOST 3031.2-2015
Data archives	1 diagnostics archive (6,000 entries) 2 configurable measuring period archives (6,000 entries each)
Logbooks	Event logbook (1,000 entries) Parameter logbook (200 entries) Metrology logbook (50 entries)

8.3 **Design pressure and design temperature**

Please refer to the supplied acceptance test certificate (EN 10204 - 3.1) and the type plate on the meter body for the actual values for the design pressure and design temperature for your specific device.

Fig. 61 Example acceptance test certificate (EN10204 - 3.1)

FLAWSIC600-XT
Abnahmeprüfzeugnis / Inspection certificate (EN 10204 - 3.1)

Zeugnis Nr. / Certificate No.: 24330027

1 Allgemeine Angaben / General

Kunden-Bestell-Nr. / Customer Order No. :	-	
Produkt Typ / Product type:	FLAWSIC600-XT C	
Modellbezeichnung / Model Name:	FGC-4P3D08-DI1E-T218	
Serien-Nr. / Serial No. :	24330027	
Baujahr / Year of manufacturing :	2024	
Auslegungsdruck / design pressure:	100 bar(g)	Kategorie / Category III
Auslegungstemperatur / Design Temperature:	-40 ...80 °C	

Fig. 62 Example meter body type plate

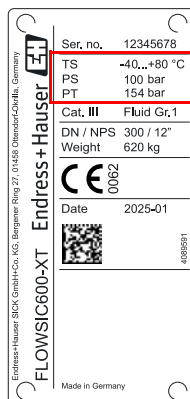

TS Minimum/Maximum design temperature
 PS Maximum design pressure
 PT Test pressure

8.4 **Measuring ranges**

Table 20 Measuring ranges (metric)

Meter size	Extended flow rate range acc. MID				Non-fiscal maximum flow rate [m ³ /h]
	Extended MID minimum flow rate [m ³ /h]	Standard flow rate range acc. MID			
		Standard MID minimum flow rate [m ³ /h]	MID transition flow rate [m ³ /h]	MID maximum flow rate [m ³ /h]	
Extended Q _{min}	Standard Q _{min}	acc. ISO17089 Q _t	Standard Q _{max}	Extended maximum Q _{max}	
DN80 (3")	5	8	40	650	1,000
DN100 (4")	8	13	65	1,000	1,600
DN150 (6")	16	20	100	2,500	3,000
DN200 (8")	20	32	160	4,000	4,500
DN250 (10")	25	50	240	6,500	7,000
DN300 (12")	35	65	310	7,800	8,000
DN350 (14")	45	80	420	10,000	10,000
DN400 (16")	60	120	550	13,000	14,000
DN450 (18")	100	130	700	16,000	17,000
DN500 (20")	130	200	850	20,000	20,000
DN550 (22")	150	260	1,000	24,000	24,000
DN600 (24")	180	320	1,200	28,000	32,000
DN650 (26")	240	450	1,400	32,000	35,000
DN700 (28")	280	650	1,700	36,000	40,000
DN750 (30")	320	650	1,900	40,000	45,000
DN800 (32")	360	800	2,200	43,000	50,000
DN850 (34")	400	900	2,500	47,000	55,000
DN900 (36")	450	1,000	2,800	51,000	66,000
DN950 (38")	500	1,100	3,100	56,000	70,000
DN1000 (40")	550	1,200	3,400	60,000	80,000
DN1050 (42")	600	1,300	3,800	65,000	85,000
DN1100 (44")	650	1,400	4,100	70,000	90,000
DN1150 (46")	700	1,500	4,500	72,000	95,000
DN1200 (48")	750	1,600	4,800	80,000	100,000
DN1300 (52")	900	1,700	5,600	90,000	110,000
DN1400 (56")	1,000	1,800	6,500	100,000	120,000

Only the "Standard flow range according to MID" is applicable for device version FLOWIC600-XT C. The maximum gas velocity in the pipe is limited to 40 m/s in configurations with flow conditioner.

¹ Q_{min} values may deviate (see OIML R137 certificate)

Table 21 Measuring ranges (imperial)
 Conversion of values allowed by MID to imperial units (rounded). Values according to MID, see
 → p. 129, Table 20.

Meter size	Extended flow rate range acc. MID				Non-fiscal maximum flow rate [ft ³ /h]
	Extended MID minimum flow rate [ft ³ /h]	Standard flow rate range acc. MID			
		Standard MID minimum flow rate [ft ³ /h]	MID transition flow rate [ft ³ /h]	MID maximum flow rate [ft ³ /h]	
Extended Q _{min}	Standard Q _{min}	acc. ISO17089 Q _t	Standard Q _{max}	Extended maximum Q _{max}	
3" (DN80)	180	280	1,400	23,000	35,000
4" (DN100)	290	460	2,300	35,300	56,000
6" (DN150)	570	710	3,500	88,000	106,000
8" (DN200)	710	1,130	5,700	141,300	159,000
10" (DN250)	880	1,800	8,500	230,000	247,000
12" (DN300)	1,200	2,300	10,900	276,000	283,000
14" (DN350)	1,600	2,800	14,800	353,000	354,000
16" (DN400)	2,100	4,200	19,400	459,000	495,000
18" (DN450)	3,500	4,600	24,700	565,000	602,000
20" (DN500)	4,600	7,100	30,000	706,000	708,000
22" (DN550)	5,300	9,200	35,000	848,000	850,000
24" (DN600)	6,400	11,300	42,000	989,000	1,133,000
26" (DN650)	8,500	15,900	49,000	1,130,000	1,240,000
28" (DN700)	9,900	23,000	60,000	1,271,000	1,420,000
30" (DN750)	11,300	23,000	67,000	1,413,000	1,590,000
32" (DN800)	12,700	28,300	78,000	1,519,000	1,770,000
34" (DN850)	14,200	31,800	88,000	1,660,000	1,950,000
36" (DN900)	15,900	35,300	99,000	1,801,000	2,337,000
38" (DN950)	17,700	38,800	109,000	1,978,000	2,479,000
40" (DN1000)	19,500	42,400	120,000	2,119,000	2,833,000
42" (DN1050)	21,200	45,900	134,000	2,296,000	3,010,000
44" (DN1100)	23,000	49,400	145,000	2,472,000	3,187,000
46" (DN1150)	24,800	53,000	159,000	2,543,000	3,364,000
48" (DN1200)	26,600	56,500	170,000	2,825,000	3,541,000
52" (DN1300)	31,800	60,000	198,000	3,178,000	3,885,000
56" (DN1400)	35,300	63,600	230,000	3,532,000	4,238,000

Only the "Standard flow range according to MID" is applicable for device version FLWSIC600-XT C.
 The maximum gas velocity in the pipe is limited to 131 ft/s in configurations with flow conditioner.

¹ Q_{min} values may deviate (see OIML R137 certificate)

8.5 **Dimensions**

Fig. 63 FLOWSIC600-XT and FLOWSIC600-XT Forte

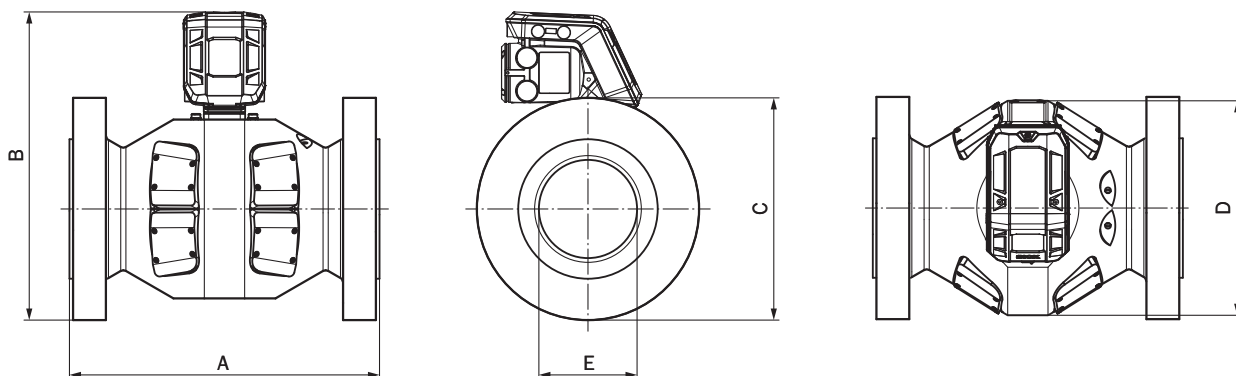

Fig. 64 FLOWSIC600-XT 2plex and FLOWSIC600-XT Quatro

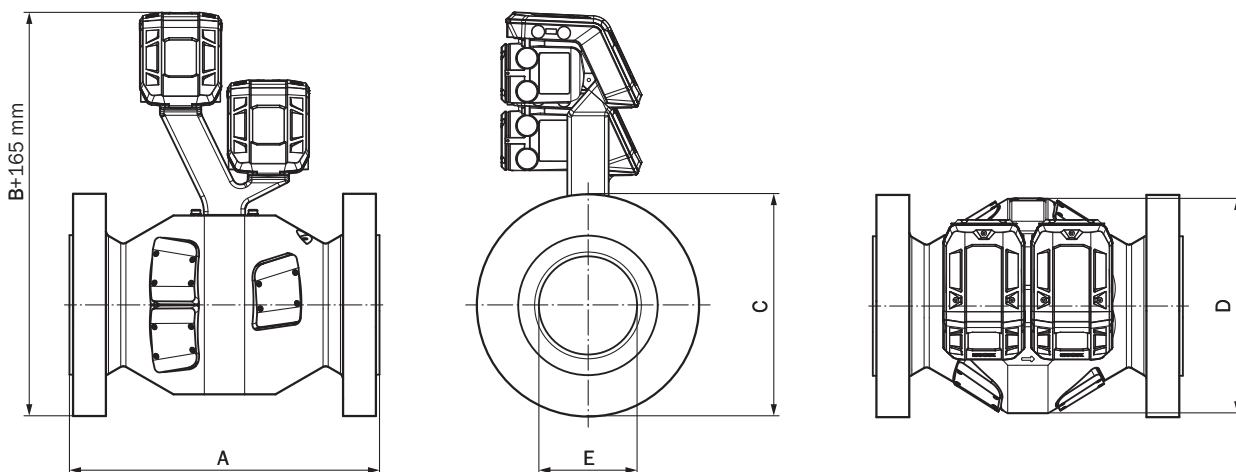

Fig. 65 FLOWSIC600-XT: 3" version for pressure levels up to Class 600/PN100

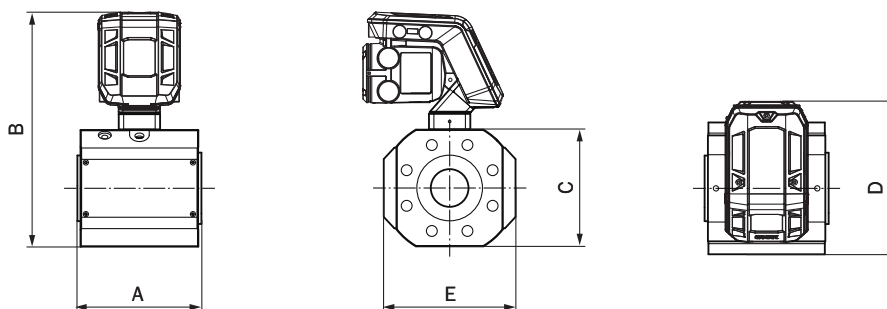

Fig. 66 FLOWSIC600-XT: 3" - 5D version

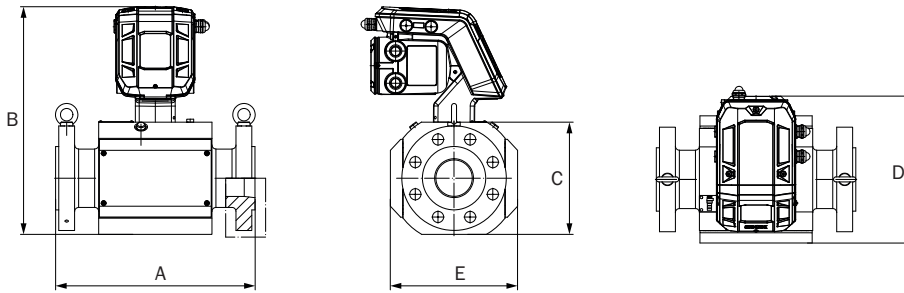

Table 22 Dimensions

Nominal pipe size	Connection flange	Standard	Weight ^[1]	Length (A)	Height ^[2] (B)	Flange diameter (C)	Outer diameter, meter body (D)	Inner diameter (E)	
			[kg]	[mm]	[mm]	[mm]	[mm]	[mm]	
3"	cl. 150	ANSI B16.5	73	240 / 400 ^[3]	455	225	269,5	73	
	cl. 300								
	cl. 600								
	cl. 900		120	400					461
DN80	PN 16	EN 1092-1	75	240/ 400 ^[3]	454	200			
	PN 63					215			
	PN 100					230			
4"	cl. 150	ANSI B16.5	118	300/ 500 ^[3]	480	250	291	95	
	cl. 300								
	cl. 600		130	500					290
	cl. 900								220
DN100	PN 16	EN 1092-1	110	300/ 500 ^[3]		250			
	PN 63	EN 1092-1	120			265			
	PN 100	EN 1092-1	126						
6"	cl. 150	ANSI B16.5	128	450	505	280	332	142	
	cl. 300		145		525				320
	cl. 600		170		542,5				355
	cl. 900		238		750				540
DN150	PN 16	EN 1092-1	140	450		285			
	PN 63	EN 1092-1	162			345			
	PN 100	EN 1092-1	176			355			
8"	cl. 150	ANSI B16.5	255	600	617	345	415	190	
	cl. 300		276						380
	cl. 600		316						420
	cl. 900		360						470
DN200	PN 16	EN 1092-1	260			340			
	PN 63	EN 1092-1	298			415			
	PN 100	EN 1092-1	360			430			

Nominal pipe size	Connection flange	Standard	Weight ^[1]	Length (A)	Height ^[2] (B)	Flange diameter (C)	Outer diameter, meter body (D)	Inner diameter (E)	
			[kg]	[mm]	[mm]	[mm]	[mm]	[mm]	
10 "	cl. 150	ANSI B16.5	377	750	691	405	480	235	
	cl. 300		411			445			
	cl. 600		485			510			
	cl. 900		528			545			
DN250	PN 16	EN 1092-1	383			405			
	PN 63	EN 1092-1	434			470			
	PN 100	EN 1092-1	486			505			
12 "	cl. 150	ANSI B16.5	445	900	728	485	500	270	
	cl. 300		494			520			
	cl. 600		560			560			
	cl. 900		645			685			610
DN300	PN 16	EN 1092-1	441		728	460			
	PN 63	EN 1092-1	509			530			
	PN 100	EN 1092-1				638			585
14 "	cl. 150	ANSI B16.5	475	1050	642	535	540	315	
	cl. 300		600			667			585
	cl. 600		675			677			605
	cl. 900		850			700			640
DN350	PN 16	EN 1092-1	475			635			
	PN 63	EN 1092-1	625			675			600
	PN 100	EN 1092-1	750			705			655
An optional fitting length of 3D is available for all meters in size 16" and larger									
16 "	cl. 150	ANSI B16.5	672	762	844	595	610	360	
	cl. 300		760			650			
	cl. 600		857			685			
	cl. 900		926			705			
DN400	PN 16	EN 1092-1	658	762	844	580			
	PN 63	EN 1092-1	794			670			
18 "	cl. 150	ANSI B16.5	660	820	754	635	620	405	
	cl. 300		760			792			710
	cl. 600		960			820			745
	cl. 900		1300	900	830	785			
DN450	Data on request								
20 "	cl. 150	ANSI B16.5	750	902	815	700	670	450	
	cl. 300		930			853			775
	cl. 600		1080			872			815
	cl. 900		1500			1000			892
DN500	PN 16	EN 1092-1	700	902	823	715			
22 "	Data on request								
DN550	Data on request								
24 "	cl. 150	ANSI B16.5	1090	991	927	815	760	540	
	cl. 300		1390			978			915
	cl. 600		1615			990			940
	cl. 900		2100	1200	1040	1040			
DN600	PN 16	EN 1092-1	1015	991	940	840			

Nominal pipe size	Connection flange	Standard	Weight ^[1]	Length (A)	Height ^[2] (B)	Flange diameter (C)	Outer diameter, meter body (D)	Inner diameter (E)
			[kg]	[mm]	[mm]	[mm]	[mm]	[mm]
26 "	cl. 150	ASME B16.47	1475	1050	965	870	828	585
	cl. 300		1825		1016	972		
	cl. 600		2100		1038	1016		
	cl. 900		2500	1073	1086			
DN650	Data on request							
28 "	cl. 150	ASME B16.47	1950	1100	1027	927	862	630
	cl. 300		2225		1080	1035		
	cl. 600		2450		1100	1073		
	cl. 900		3000	1150	1169			
DN700	Data on request							
30 "	cl. 150	ASME B16.47	2195	1150	1080	985	902	675
	cl. 300		2545		1135	1092		
	cl. 600		2820		1154	1130		
	cl. 900		3350	1205	1232			
DN750	Data on request							
32 "	cl. 150	ASME B16.47	2485	1200	1145	1061	979	720
	cl. 300		2835		1190	1150		
	cl. 600		3110		1212	1194		
	cl. 900		3800	1272	1315			
DN800	Data on request							
34 "	Data on request							
DN850	Data on request							
36 "	cl. 150	ASME B16.47	3125	1250	1250	1169	1082	810
	cl. 300		3525		1300	1270		
	cl. 600		3850		1323	1315		
	cl. 900		5225	1396	1461			
DN900	Data on request							
38 "	cl. 150	ASME B16.47	3800	1300	1310	1238	1160	855
	cl. 300		3725		1275	1169		
	cl. 600		4300		1325	1270		
	cl. 900		Data on request	1421	1461			
DN950	Data on request							
40 "	cl. 150	ASME B16.47	3825	1350	1359	1289	1213	900
	cl. 300		4125		1334	1239		
	cl. 600		4675		1375	1321		
	cl. 900		Data on request	1470	1512			
DN1000	Data on request							
42 "	cl. 150	ASME B16.47	4675	1450	1415	1346	1261	945
	cl. 300		4650		1386	1289		
	cl. 600		5450		1444	1404		
	cl. 900		Data on request	1523	1562			
DN1050	PN 16	Data on request						
44 "	Data on request							
DN1100	Data on request							
46 "	Data on request							
DN1150	Data on request							

Nominal pipe size	Connection flange	Standard	Weight ^[1]	Length (A)	Height ^[2] (B)	Flange diameter (C)	Outer diameter, meter body (D)	Inner diameter (E)
			[kg]	[mm]	[mm]	[mm]	[mm]	[mm]
48"	cl. 150	ASME B16.47	6400	1600	1574	1511	1416	1080
	cl. 300		6475		1552	1467		
	cl. 600		7850		1615	1594		
	cl. 900		12100	1900	1711	1785		
DN1200	Data on request							

[1] Devices with one Signal Processing Unit; devices with two Signal Processing Units: weight + 7 kg

[2] Optional neck extension: B + 200 mm

[3] For versions with flange in 5DN overall length

FLOWSIC600-XT

9 Annex

- Connection diagrams for operation of the FLOWSIC600-XT in accordance with ATEX/IECEX
- Connection diagrams for operation of the FLOWSIC600-XT in accordance with CSA
- Wiring examples
- Power input of the possible input and output configurations
- Type plates (examples)
- Model name

9.1

Connection diagrams for operation of the FLOWsic600-XT in accordance with ATEX/IECEx

Fig. 67 Connection diagram 9236580 (page 1)

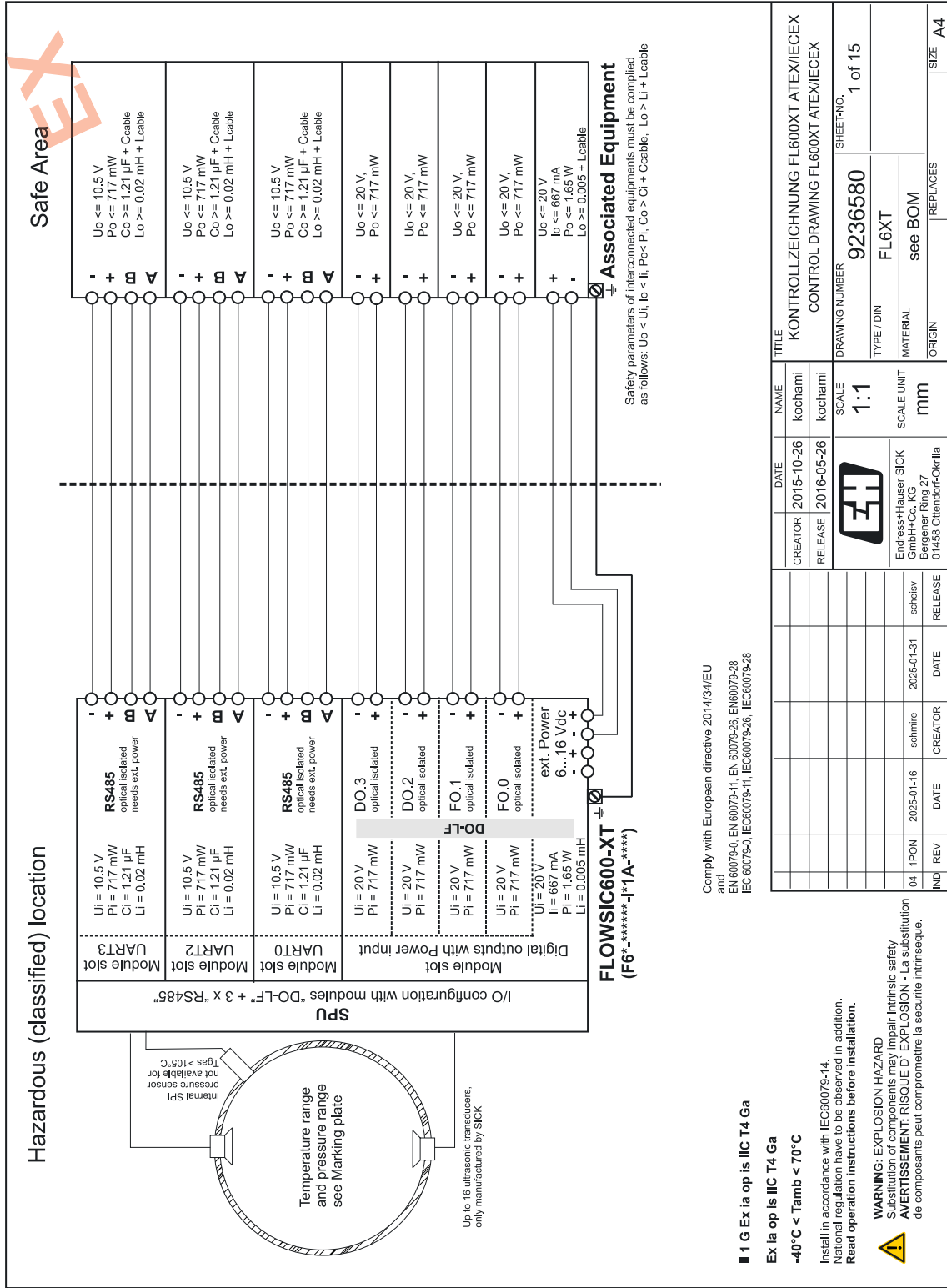

Fig. 68 Connection diagram 9236580 (page 5)

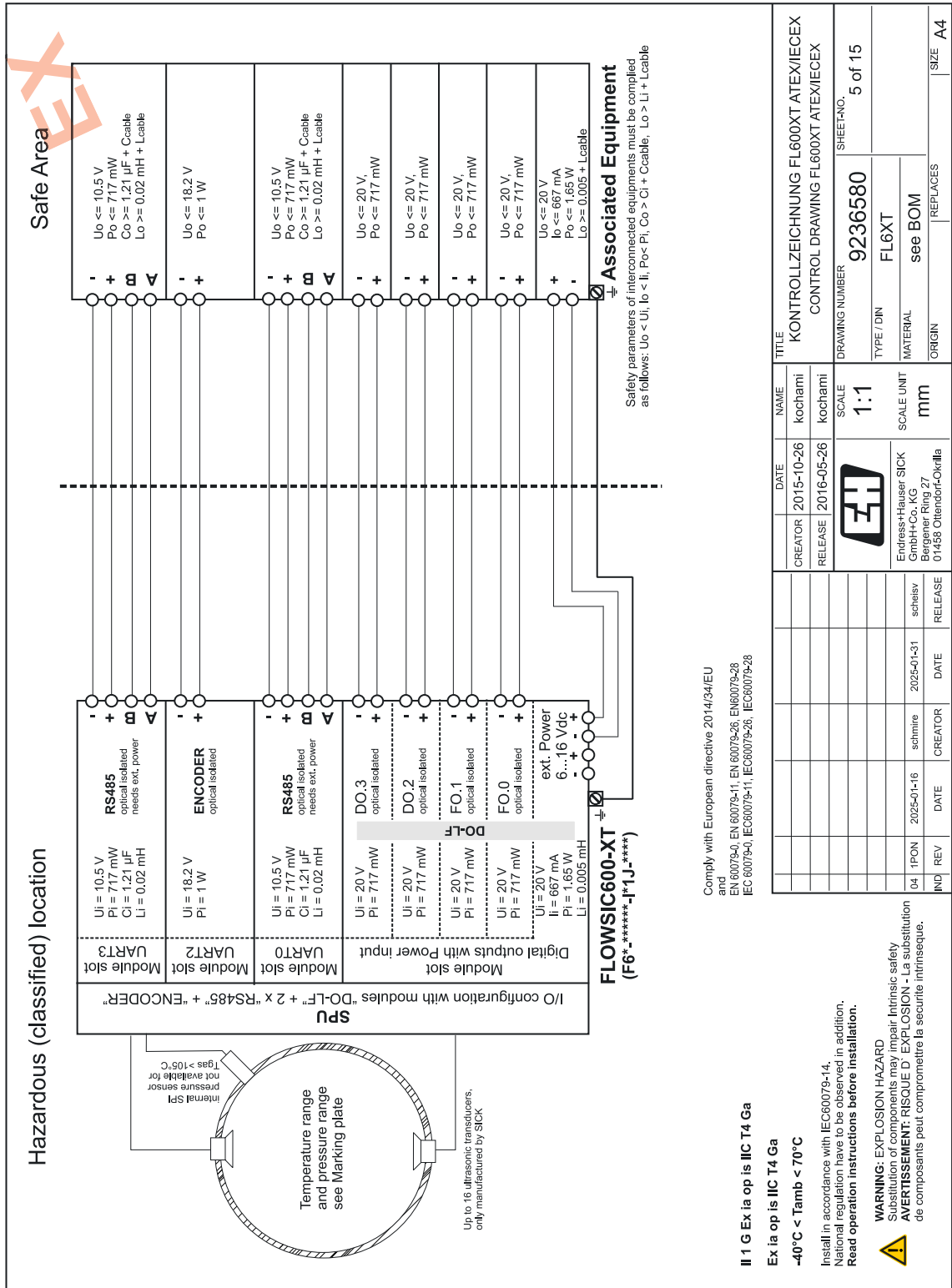
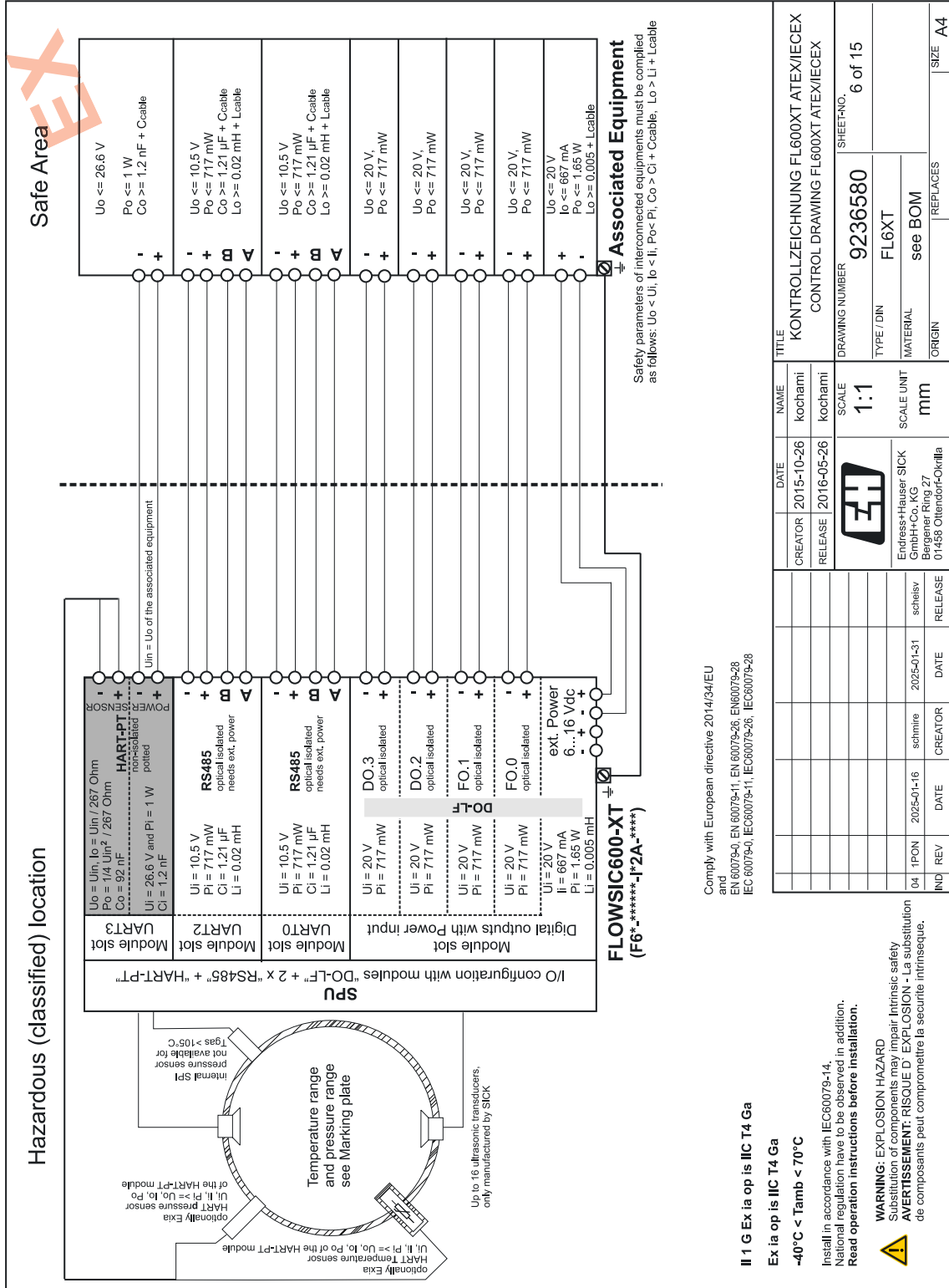

Fig. 69 Connection diagram 9236580 (page 6)



Comply with European directive 2014/34/EU and EN 60079-0, EN 60079-11, EN 60079-26, EN 60079-28, EN 60079-30, IEC60079-11, IEC60079-26, IEC60079-28

II 1 G Ex ia op is IIC T4 Ga

Ex ia op is IIC T4 Ga

-40°C < Tamb < 70°C

Install in accordance with IEC60079-14. National regulation have to be observed in addition. **Read operation instructions before installation.**

WARNING: EXPLOSION HAZARD
 Substitution of components may impair intrinsic safety.
AVERTISSEMENT: RISQUE D'EXPLOSION - La substitution de composants peut compromettre la sécurité intrinsèque.



CREATOR	2015-10-26	NAME	kochami	TITLE	KONTROLLZEICHNUNG FL600XT ATEX/IECEX
RELEASE	2016-05-26	SCALE	1:1	DRAWING NUMBER	9236580
		SCALE UNIT	mm	TYPE / DIN	FL6XT
Address+Hauser SICK GmbH+Co. KG Bergener Ring 27 01458 Ottendorf-Okrilla		REPLACES	see BOM	SHEET NO.	6 of 15
IND	REV	DATE	CREATOR	DATE	RELEASE
	04	2025-01-16	schmirle	2025-01-31	schelsky
			ORIGIN	SIZE	A4

© Endress+Hauser SICK GmbH+Co. KG
 All rights reserved.

of its contents to others without explicit authorization is prohibited. Any releases thereof will have to be approved by Endress+Hauser SICK GmbH+Co. KG. The user assumes full responsibility for the correct use of the product. The user is liable for the payment of damages. All rights reserved especially in the event of a patent, utility model or design.

Fig. 73 Connection diagram 9236580 (page 13)

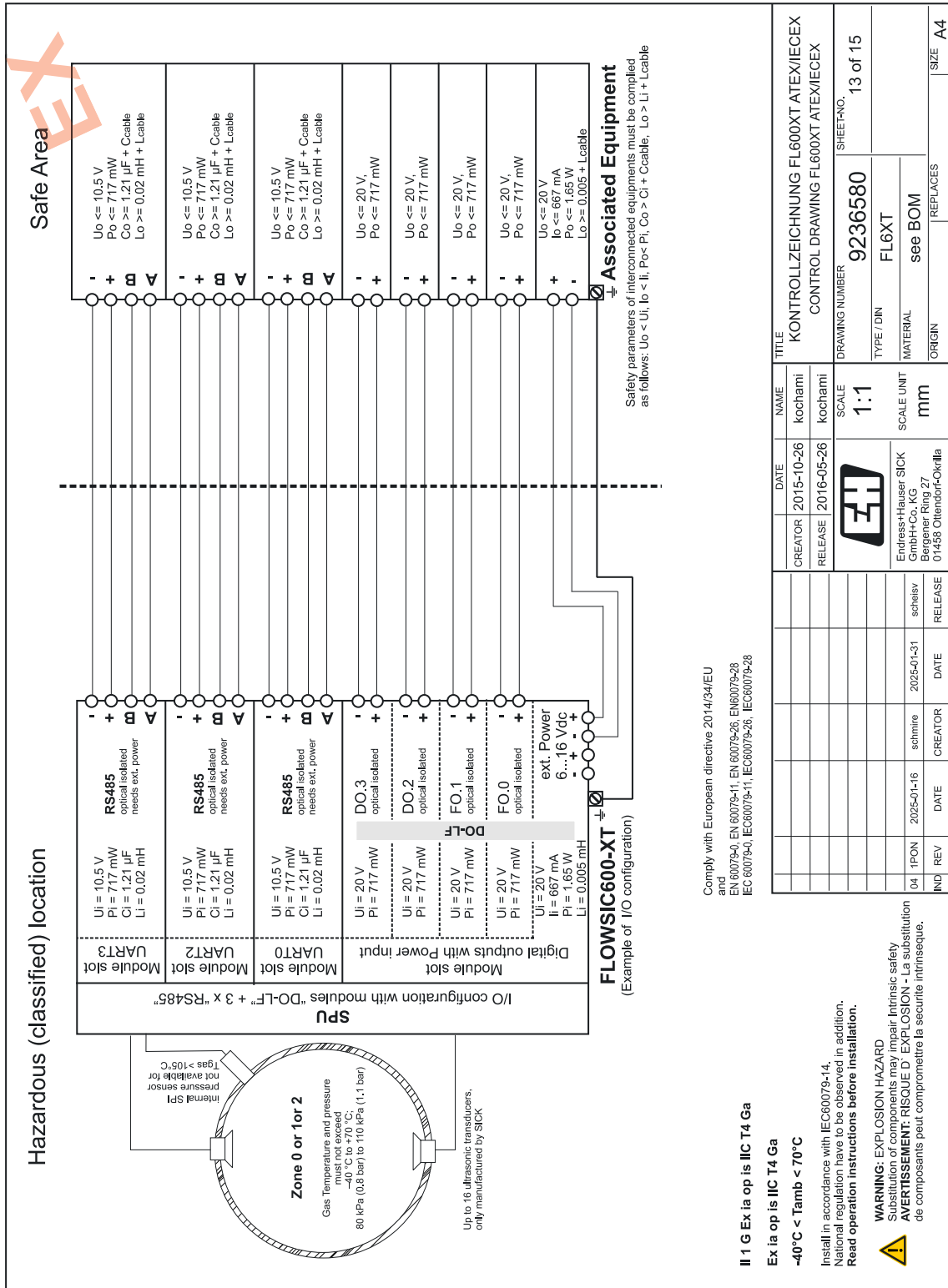

Fig. 74 Connection diagram 9236580 (page 14)

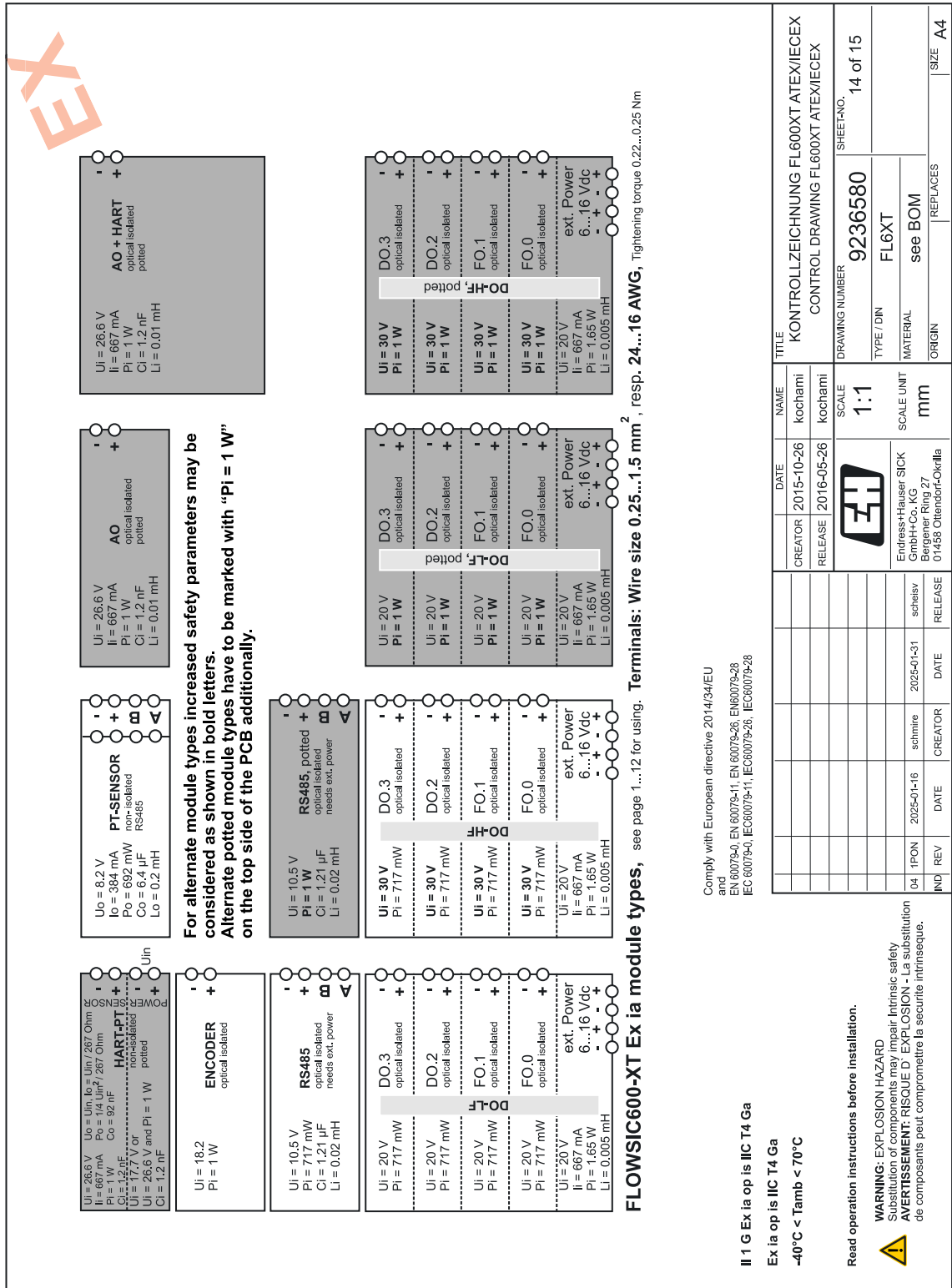
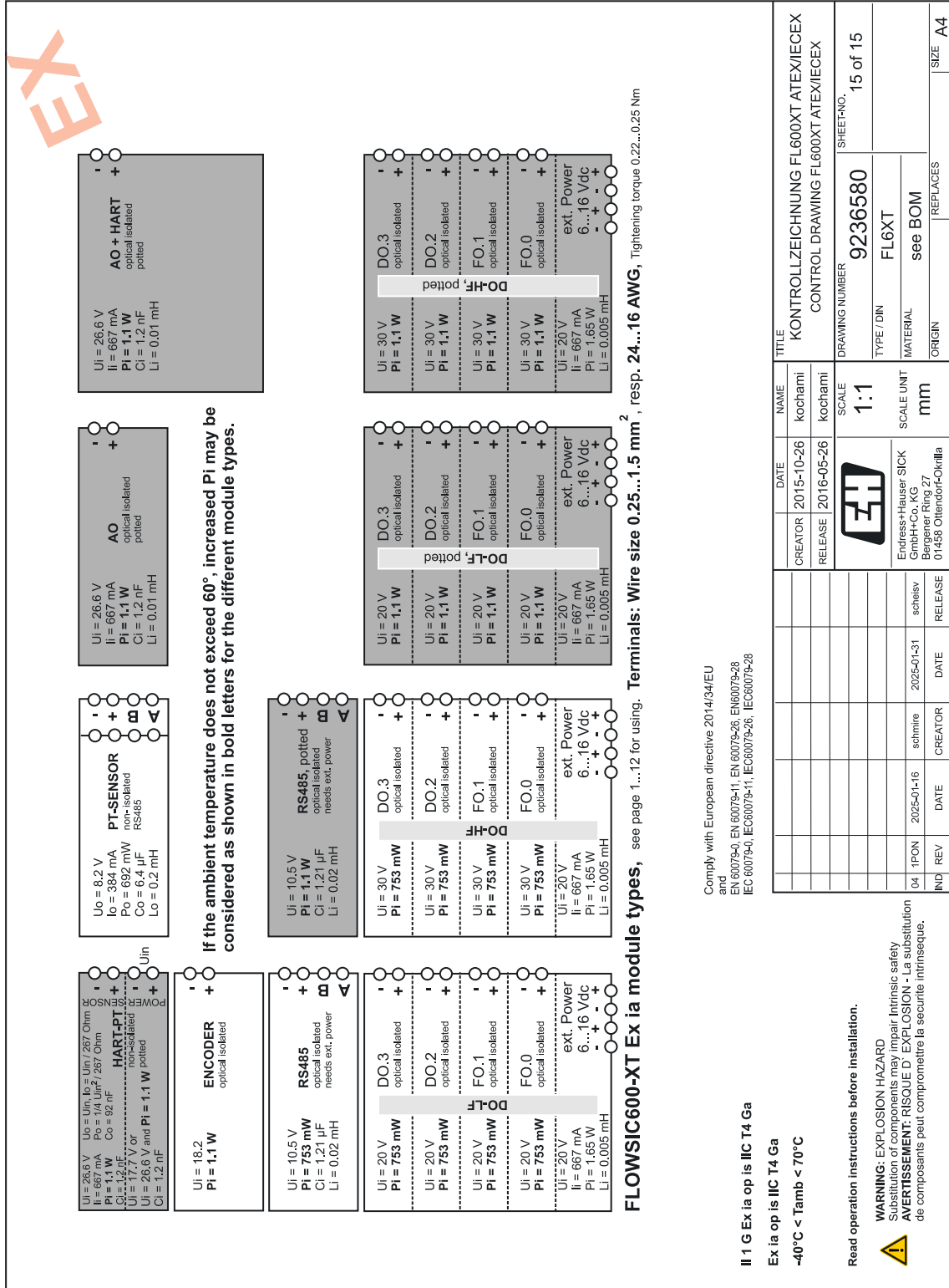

Fig. 75 Connection diagram 9236580 (page 15)



9.2

Connection diagrams for operation of the FLWSIC600-XT in accordance with CSA

Fig. 76 Connection diagram 9236581 (page 1)

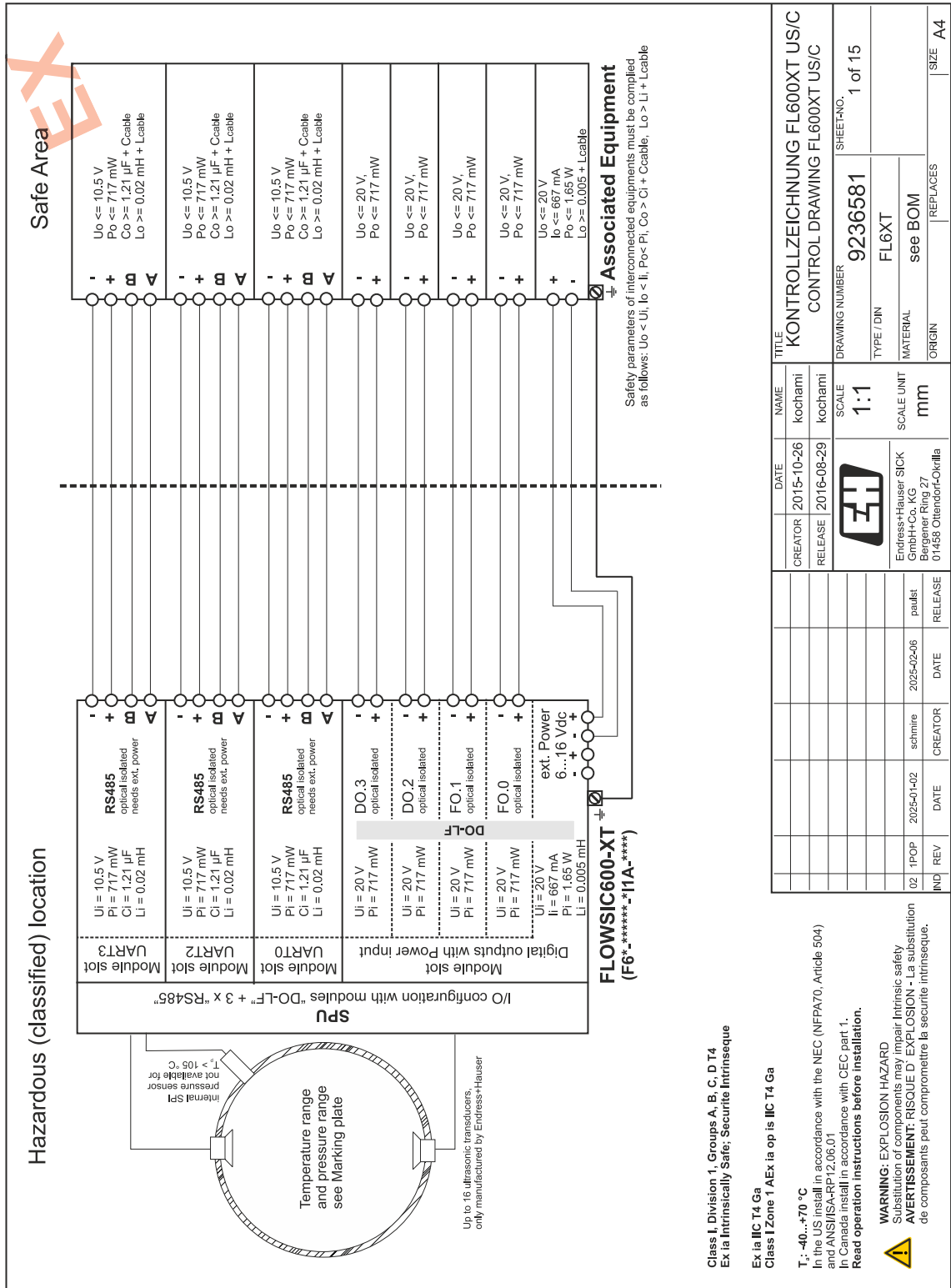
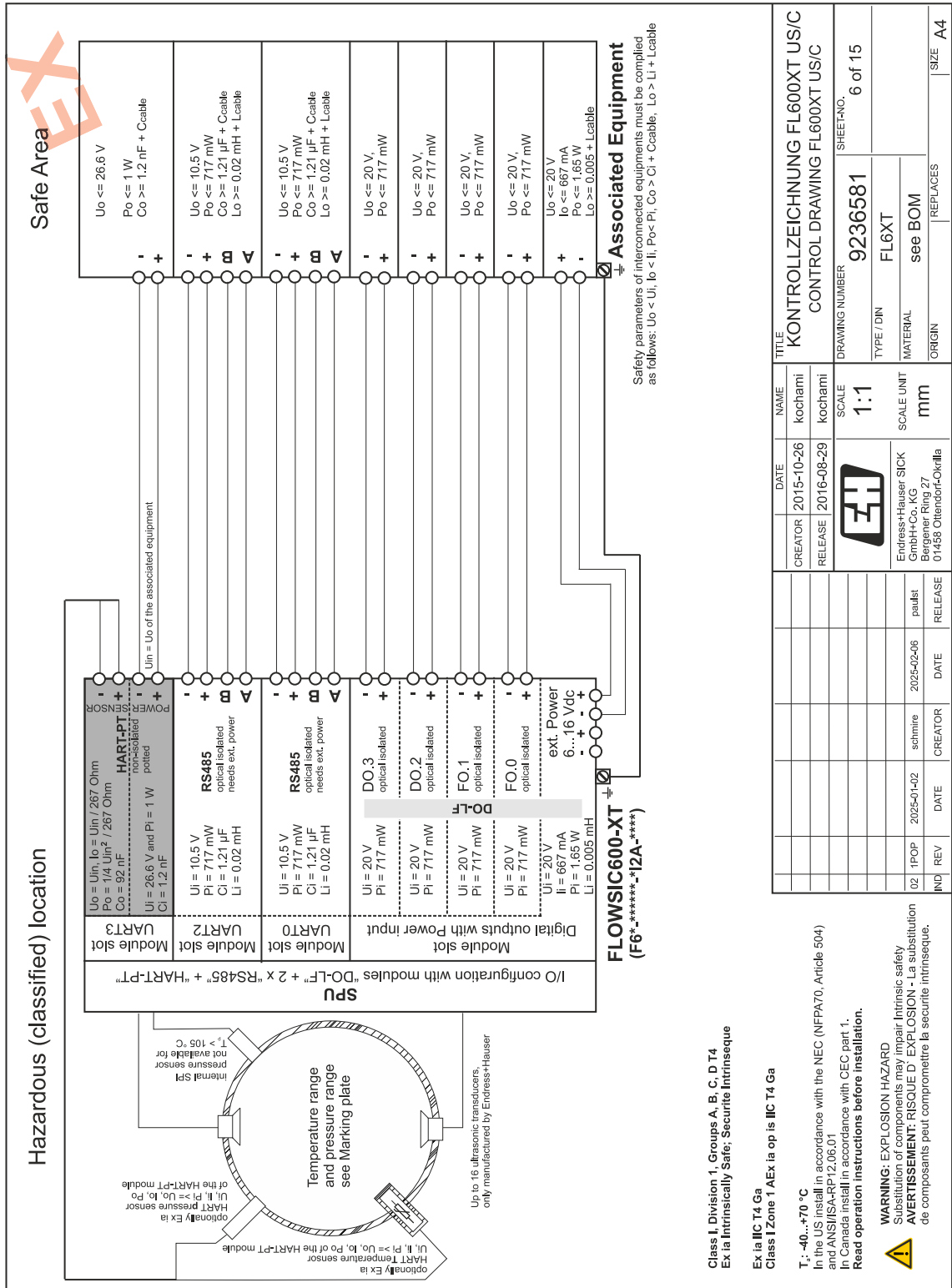

Fig. 78 Connection diagram 9236581 (page 6)



IND	REV	DATE	CREATOR	DATE	NAME	TITLE
02		2025-04-02	schmirle	2025-02-06	paulet	KONTROLLZEICHNUNG FL600XT US/C
						CONTROL DRAWING FL600XT US/C
						DRAWING NUMBER 9236581
						SHEET NO. 6 of 15
						TYPE / DIN FL6XT
						MATERIAL see BOM
						ORIGIN REPLACES
						SIZE A4

Class I, Division 1, Groups A, B, C, D T4
Ex ia Intrinsically Safe; Secure Intrinsique

Class I Zone 1 AEx ia op is IIC T4 Ga

$T_1: -40...+70 \text{ }^\circ\text{C}$

In the US install in accordance with the NEC (NFPA70, Article 504) and ANSI/ISA-RP 12.06.01

In Canada install in accordance with CEC part 1.

Read operation instructions before installation.

WARNING: EXPLOSION HAZARD
Substitution of components may impair intrinsic safety

AVERTISSEMENT: RISQUE D'EXPLOSION - La substitution de composants peut compromettre la sécurité intrinsèque.

© Endress+Hauser SICK GmbH+Co. KG. All rights reserved.

document, in part or in its entirety, as well as the communication of its contents to others without explicit authorization is prohibited. Any violation thereof will lead to prosecution. Orders with the label for the payment of damages. All rights reserved especially in the event of the grant of a patent, utility model or design.

Fig. 80 Connection diagram 9236581 (page 8)

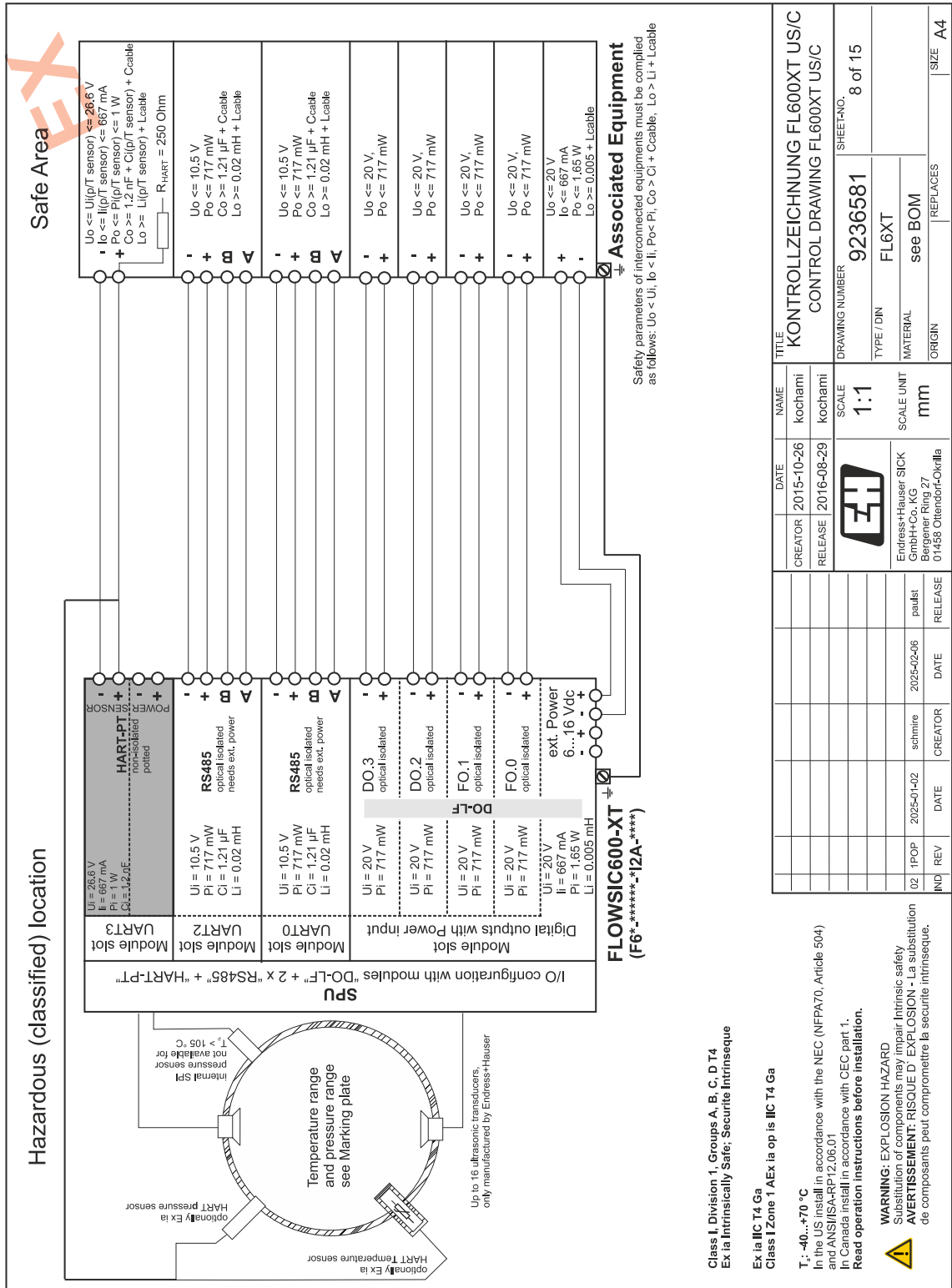
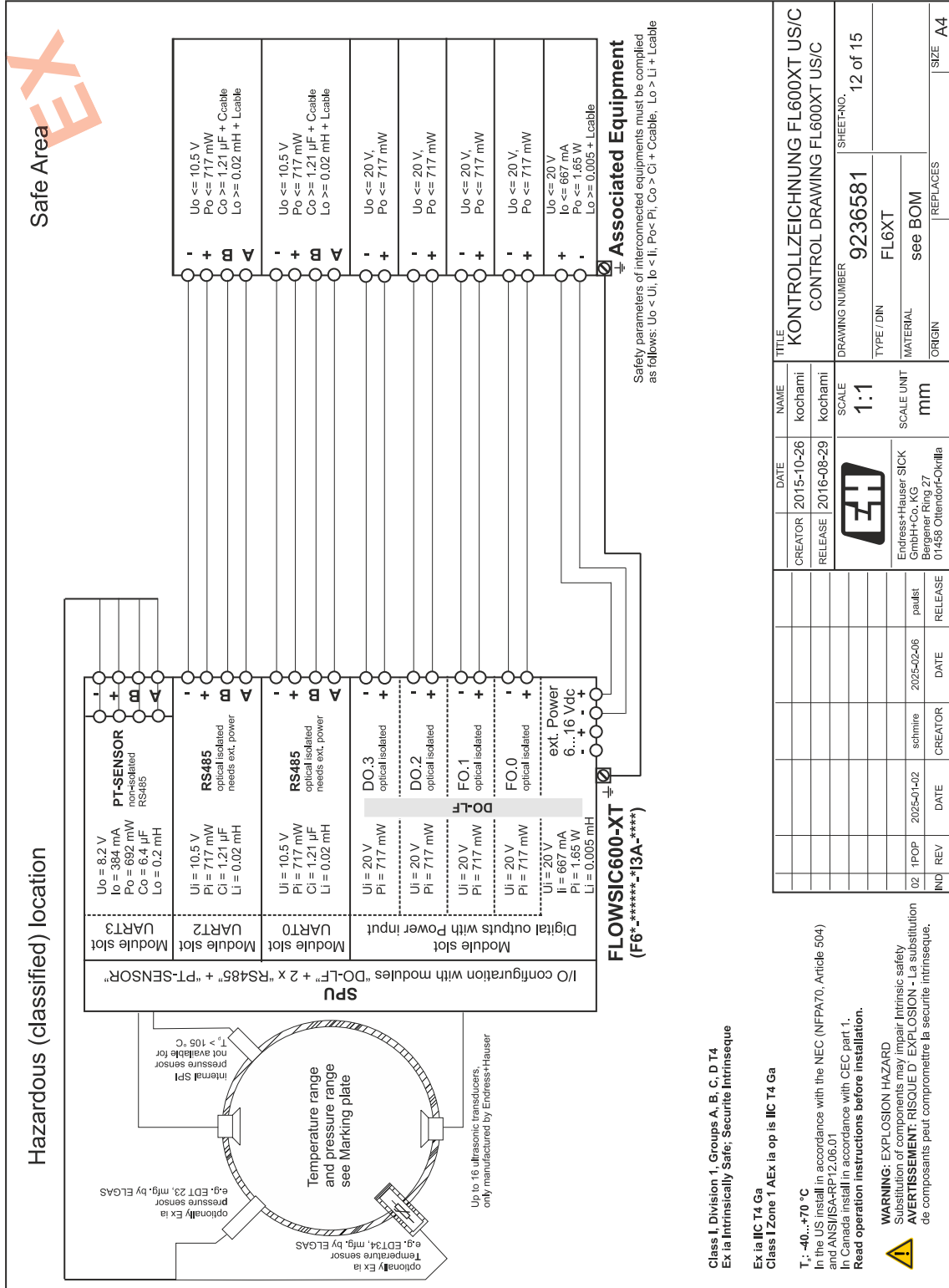

Fig. 81 Connection diagram 9236581 (page 12)



CREATOR	2015-10-26	NAME	kochami	TITLE	KONTROLLZEICHNUNG FL600XT US/C		
RELEASE	2016-08-29	SCALE	1:1	DRAWING NUMBER	9236581		
			SCALE UNIT	mm	SHEET/NO.	12 of 15	
Endress+Hauser SICK GmbH+Co. KG Bergener Ring 27 01458 Ottendorf-Okrilla			ORIGIN	see BOM	REPLACES		
IND	REV	DATE	CREATOR	DATE	RELEASE	SIZE	A4
02		2025-01-02	schmirle	2025-02-06	paulst		

Class I, Division 1, Groups A, B, C, D T4
Ex ia Intrinsically Safe; Secure Intrinsic
Class I Zone 1 AEx ia op is IIC T4 Ga

T_a: -40...+70 °C
 In the US install in accordance with the NEC (NFPA70, Article 504) and ANSI/ISA-84-00.01
 In Canada install in accordance with CEC part 1.
Read operation instructions before installation.

WARNING: EXPLOSION HAZARD
 Substitution of components may impair intrinsic safety
AVERTISSEMENT: RISQUE D'EXPLOSION - La substitution de composants peut compromettre la sécurité intrinsèque.

Fig. 82 Connection diagram 9236581 (page 13)

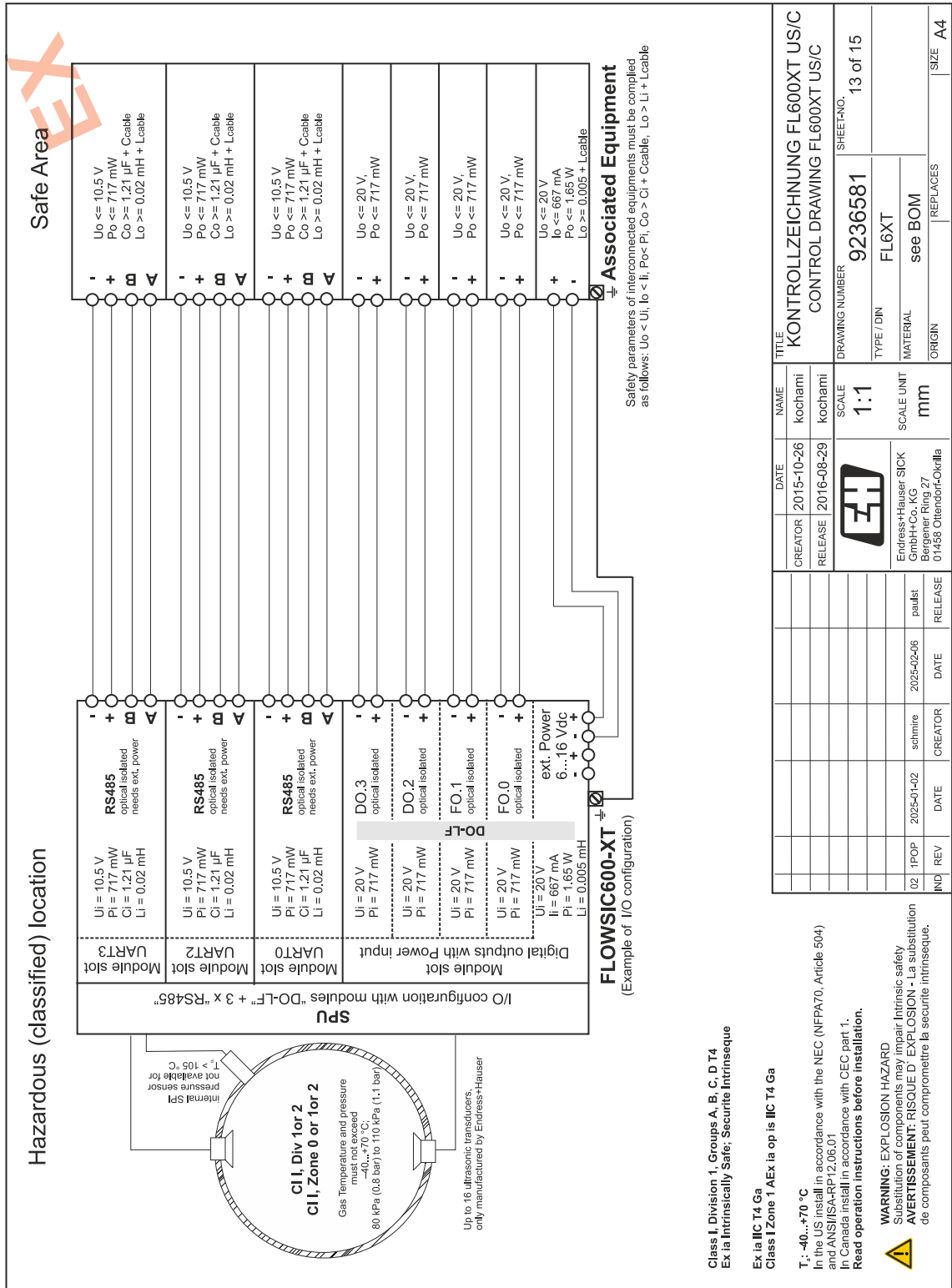
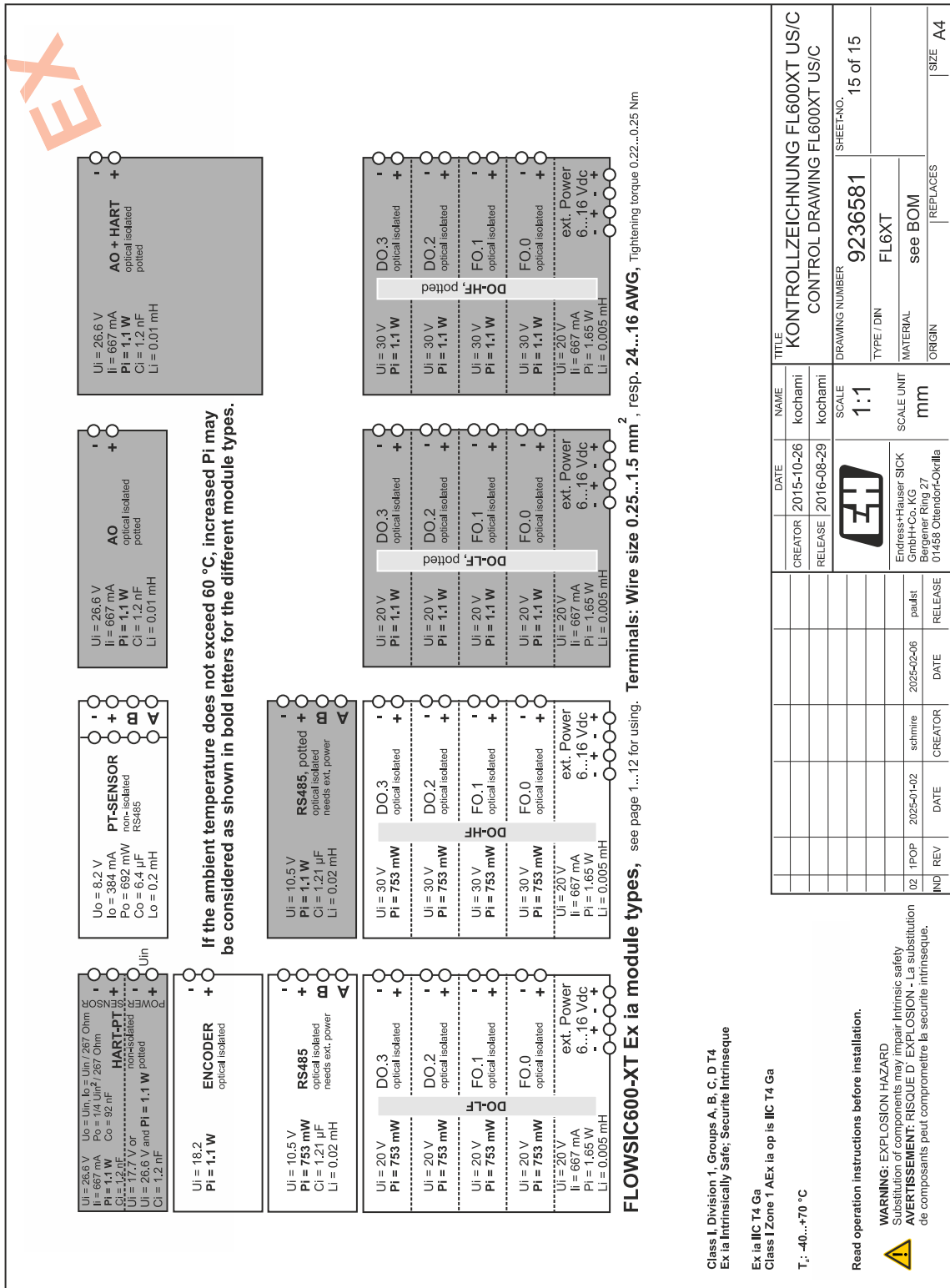

Fig. 84 Connection diagram 9236581 (page 15)



9.3 Wiring examples

9.3.1 Ex-d (flameproof enclosure)

Fig. 85 Wiring example Ex-d (3 x RS485)

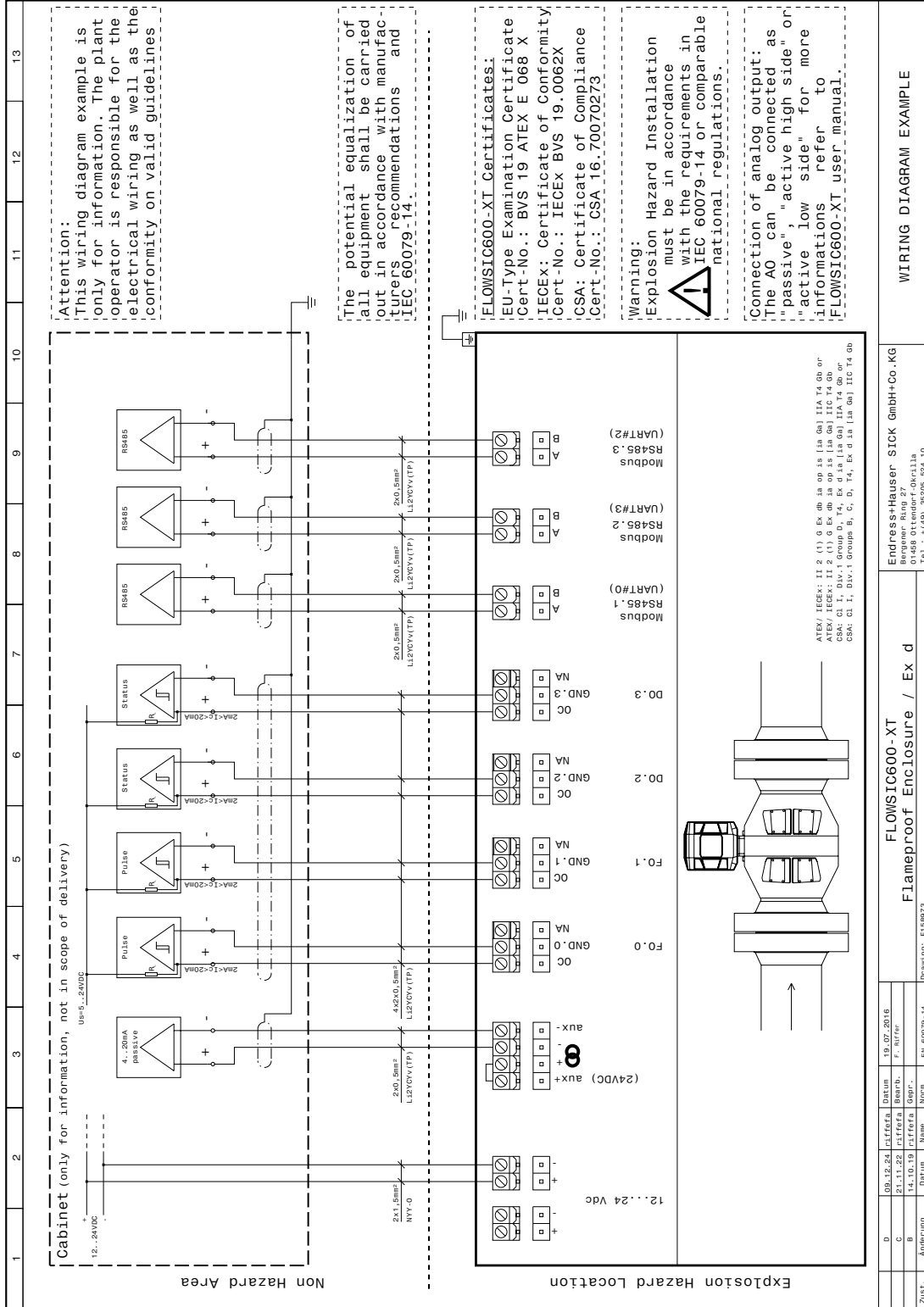

Fig. 86 Wiring example Ex-d (2 x RS485, 1 x Encoder)

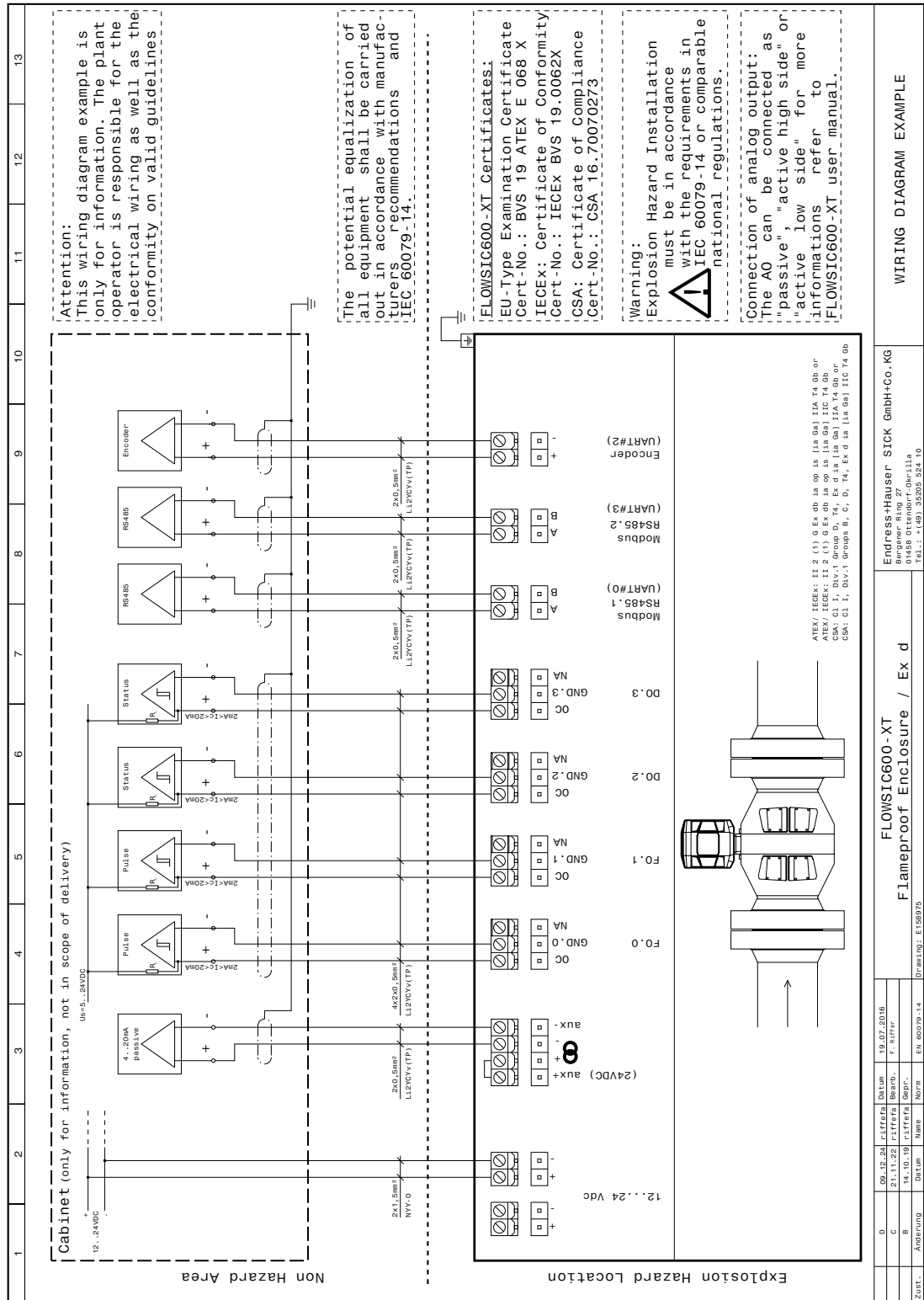

Fig. 87 Wiring example Ex-d (2 x RS485, 1 x Ethernet)

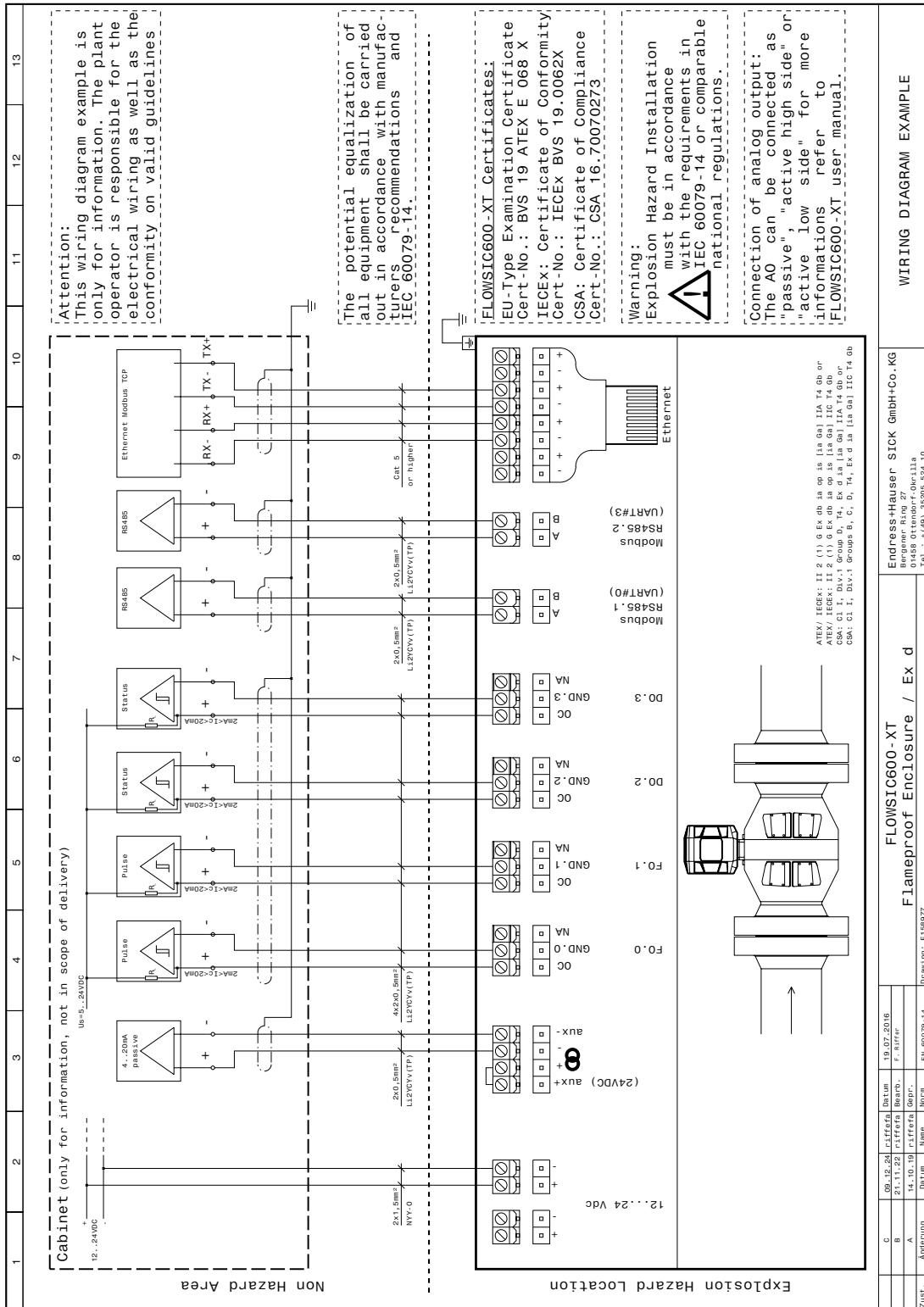
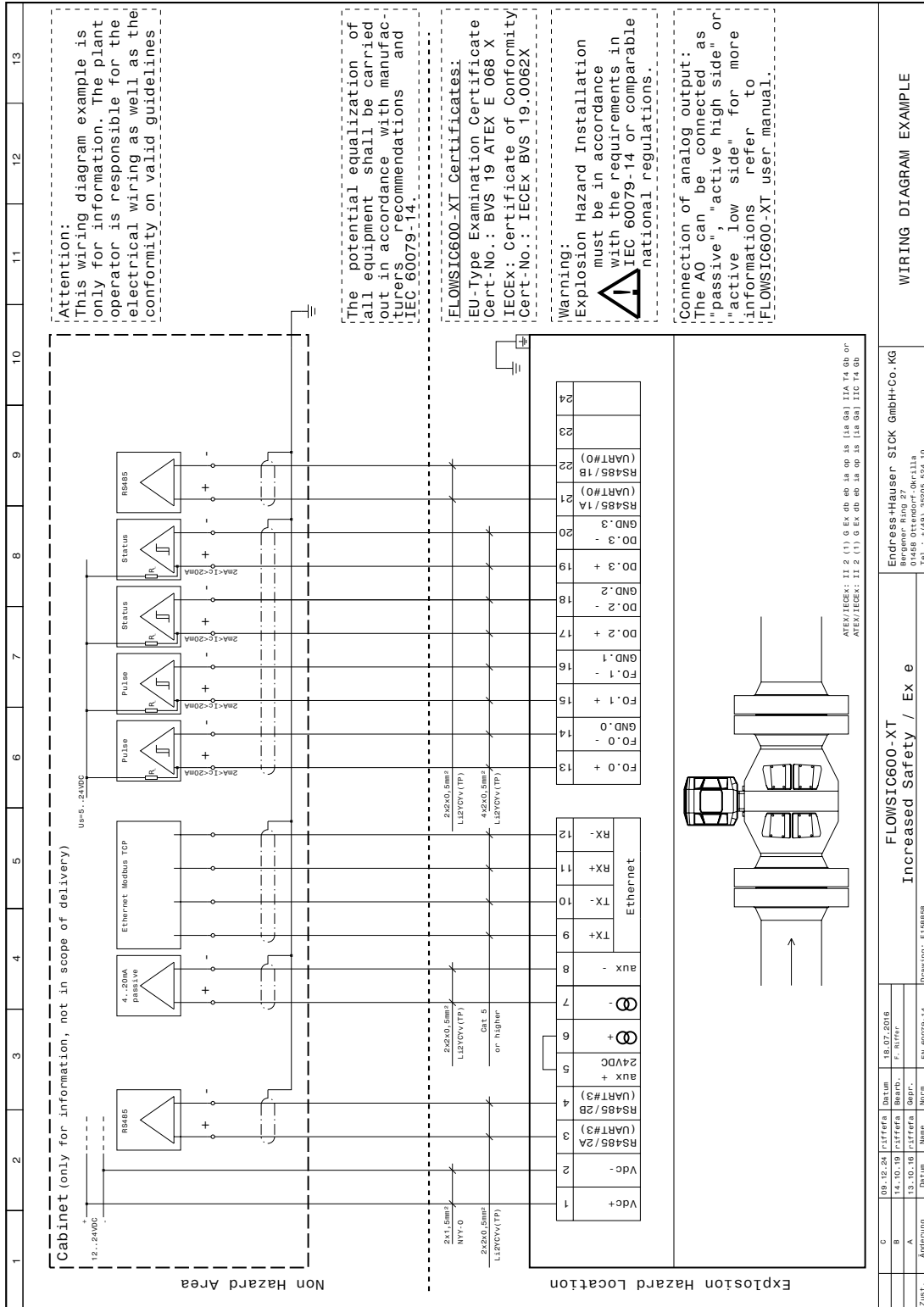

Fig. 91 Wiring example Ex-e (2 x RS485, 1 x Ethernet)



WIRING DIAGRAM EXAMPLE

FLOW SIC600-XT
Increased Safety / Ex e

Endress+Hauser SICK GmbH+Co.-KG
Bergener Ring 27
0456 Ottendorf-Oberella
Tel.: +49 3523 254-10

C	08.10.20	Flt/F0/RS	Datum	18.07.2016
B	14.06.09	Flt/F0/RS	Flt/F0/RS	F-Flt/F0
A	15.10.08	Flt/F0/RS	Flt/F0/RS	Flt/F0/RS
Zust.	Approved	Datum	EN 60079-14	Dokument: E128868

Fig. 92

Wiring example Ex-e (2 x RS485, 1 x Ethernet, HART pT)

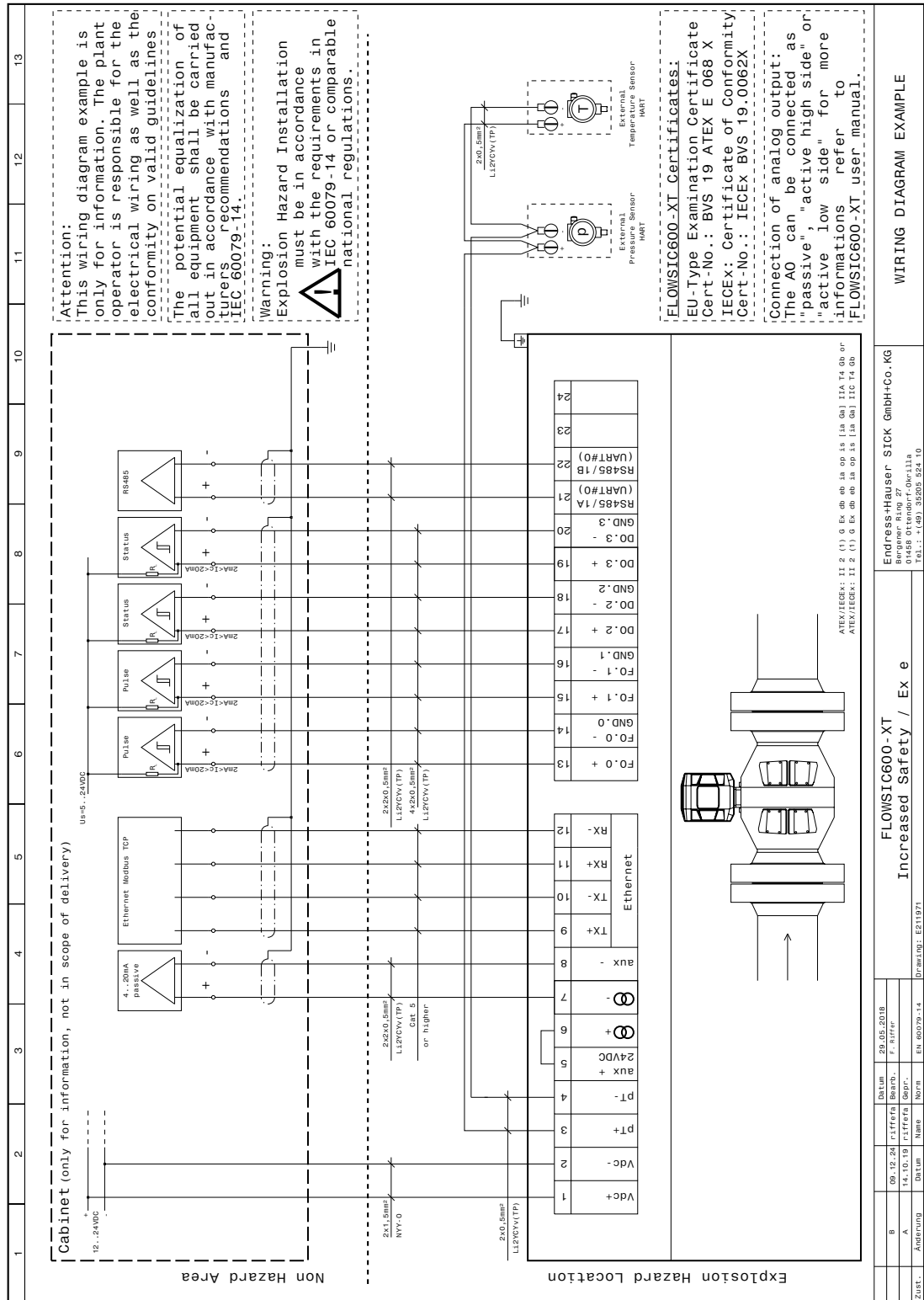

9.3.3

Ex-i (intrinsically safe)

Fig. 93

Wiring example Ex-i (3 x RS485)

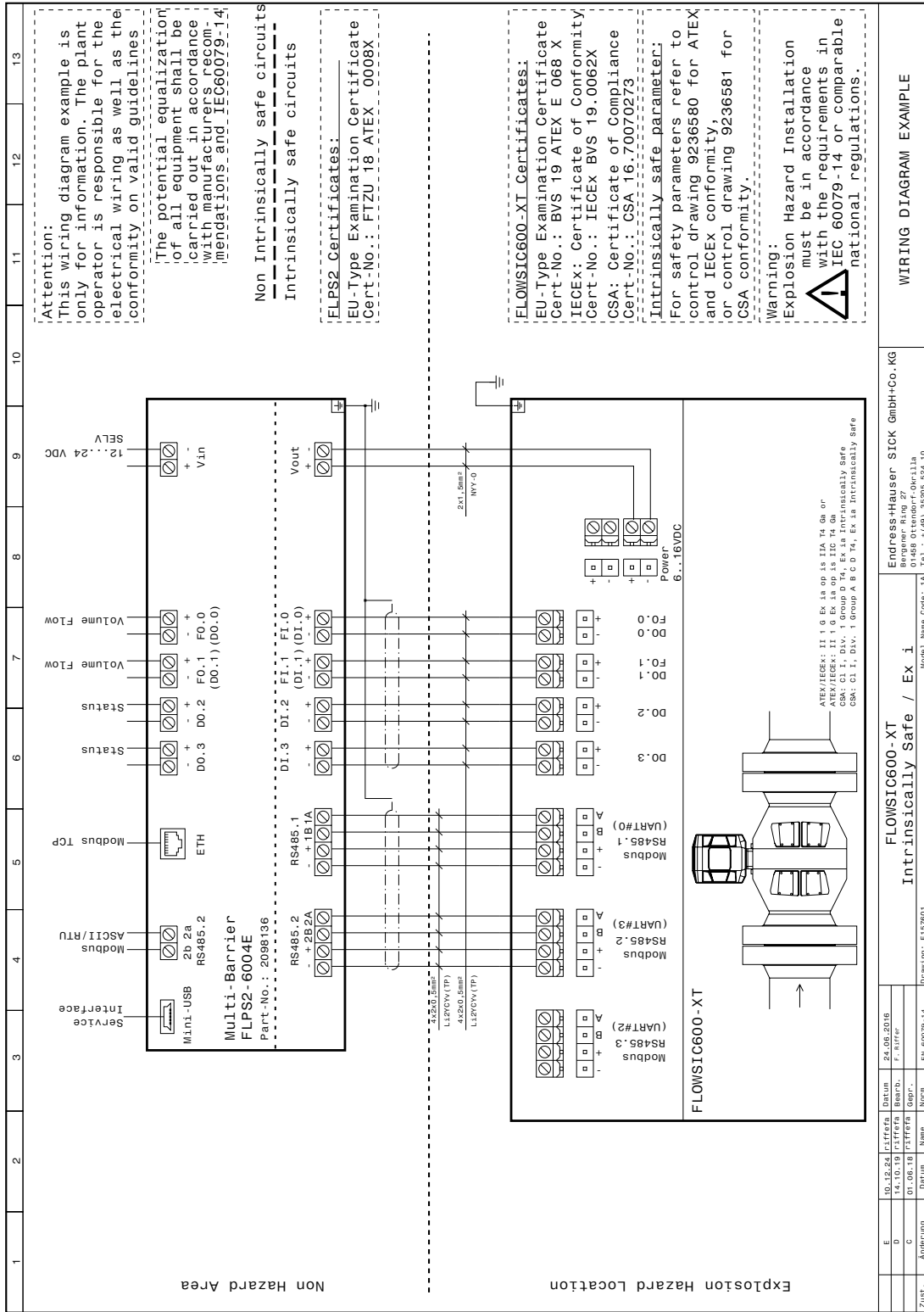

9.4

Power input of the possible input and output configurations

Fig. 95

Power input

Nr. I/O Con	Ex Variant Encoder	P _{typ} : power consumption [mW] 4 paths, 10 measurements/sec (12V operating voltage)	P _{typ} : power consumption [mW] 4+1 paths, 10 measurements/sec (12V operating voltage)	P _{typ} : power consumption [mW] 8 paths, 10 measurements/sec (12V operating voltage)
1	3*RS485/2*FO/2*DO/1*AO	1300 mW	1300 mW + 1200 mW	1420 mW
2	2*RS485/2*FO/2*DO/1*AO/1*HART (Slave)	1300 mW	1300 mW + 1200 mW	1420 mW
3	2*RS485/2*FO/2*DO/1*AO/1*Encoder	1300 mW	1300 mW + 1200 mW	1420 mW
4	2*RS485/2*FO/2*DO/1*AO/1*Ethernet	2200 mW	2200 mW + 2100 mW	2300 mW
5	HART-pt/1*RS485/2*FO/2*DO/1*AO	1450 mW	1450 mW + 1350 mW	1570 mW
6	HART-pt/1*RS485/2*FO/2*DO/1*AO/1*HART (Slave)	1450 mW	1450 mW + 1350 mW	1570 mW
7	HART-pt/1*RS485/2*FO/2*DO/1*AO/1*Encoder	1450 mW	1450 mW + 1350 mW	1570 mW
8	HART-pt/1*RS485/2*FO/2*DO/1*AO/1*Ethernet	2360 mW	2360 mW + 2260 mW	2520 mW
9	3*RS485/2*FO/2*DO	150 mW	150 mW + 95 mW	205 mW
10	2*RS485/2*FO/2*DO/1*Encoder	150 mW	150 mW + 95 mW	205 mW
11	HART-pt/2*RS485/2*FO/2*DO	150 mW	150 mW + 95 mW	205 mW

9.5 **Type plates (examples)**

Fig. 96

Ex identification (examples)
Identification according to ATEX/IECEx

Identification according to CSA

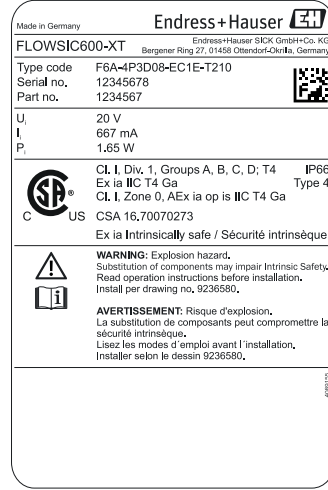

Fig. 97

Measuring Instrument Directive type plate (example)

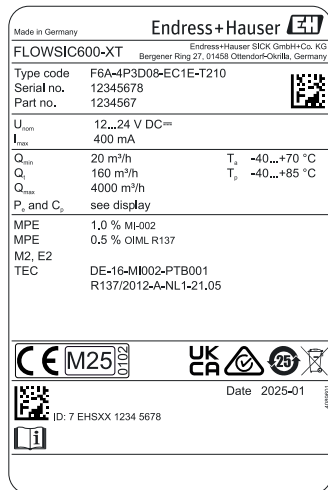

Fig. 98

Pressure Equipment Directive type plate (example)

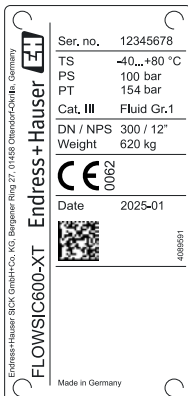



















Fig. 99 Type plate FLOWSIC600-XT Gateway (example)

Endress+Hauser 	
Made in Germany	
FLOWSIC600-XT <small>Endress+Hauser SICK GmbH+Co. KG Bergener Ring 27, 01458 Ottendorf-Ochla, Germany</small>	
Type code	F6A-4P3D08-EC1E-T210
Serial no.	12345678 
Part no.	1234567
U_{nom}	12...24 V DC ^{cm}
I_{max}	400 mA
MPE	1.0 %
M2, E2, IP66	
P_s and C_s see display	
Replacement data	
Type code	FL600-5C5D16CL0600SC0040RF2Y-S2-1DC4N1Y
Serial no.	21100001 
Part no.	1234567
Meter size	12" / DN300
Q_{max}	20 m ³ /h
Q_m	160 m ³ /h
Q_{min}	4000 m ³ /h
T_a	-40...+70 °C
T_s	-40...+85 °C
   	
Date 2025-01	
 ID: 7 EHS24 0803 2100	
 CHECK METER - Not for custody transfer measurement!	

Endress+Hauser 	
Made in Germany	
FLOWSIC600-XT <small>Endress+Hauser SICK GmbH+Co. KG Bergener Ring 27, 01458 Ottendorf-Ochla, Germany</small>	
Type code	F6A-4P3D08-EC1E-T210
Serial no.	12345678 
Part no.	1234567
U_{nom}	12...24 V DC ^{cm}
I_{max}	400 mA
MPE	1.0 %
M2, E2, IP66	
P_s and C_s see display	
   	
Date 2025-01	
 ID: 7 EHS24 0803 2100	
 CHECK METER - Not for custody transfer measurement!	

9.6 Model name

English Version E134532 07

Model Name FLOWIC600-XT

	F6A	4P	3D	08	AB	1A	T210
Product Name							
FL6XT-Standard Gases (Natural Gas)	F6A						
FL6XT-Oxygen (O ₂)	F6B						
FL6XT-C	F6C						
FL6XT-Carbon dioxide (CO ₂)	F6D						
FL6XT-Process gas	F6E						
FL6XT-Air	F6F						
FL6XT-Gateway	F6G						
FL6XT-Hydrogen (H ₂)	F6H						
FL6XT-Extended Gas Temperature Range	F6I						
FL6XT-Customized	F6X						
FL6XT-Demo Unit	F6Z						
Separation							
Path Configuration							
2 path		2P					
4 path		4P					
8 path (Forte)		8P					
4+1 path (Zplex)		5C					
4+4 path (Quatro)		4R					
1+1 paths crossed (2X)		2X					
2+2 paths crossed (4X)		4X					
Gateway 4 path		AY					
Gateway 4+1 path or 4+4 path		BY					
Installation Length							
3D			3D				
5D			5D				
6D			6D				
Short Design (<3D)			SD				
Other size			XD				
Gateway			YY				
Nominal Size							
02 inch / DN 50				02			
03 inch / DN 80				03			
04 inch / DN 100				04			
06 inch / DN 150				06			
08 inch / DN 200				08			
10 inch / DN 250				10			
Other size				##			
Gateway				YY			
Separation							
Ex Classification							
II 2 (1) G Ex db ia op is [a Ga] IIA T4 Gb							DA
II 2 (1) G Ex db ia op is [a Ga] IIC T4 Gb							DC
II 2 (1) G Ex db eb ia op is [a Ga] IIA T4 Gb							EA
II 2 (1) G Ex db eb ia op is [a Ga] IIC T4 Gb							EC
II 1G Ex ia op is IIA T4 Ga							IA
II 1G Ex ia op is IIC T4 Ga							IC
CI, Div. 1 Group D, T4, Ex db ia [a Ga] IIA T4 Gb							AD
CI, Zone 1 AEx db ia op is [a Ga] IIA T4 Gb							CD
CI, Div. 1 Groups B, C, D, T4, Ex db ia [a Ga] IIC T4 Gb,							OD
CI, Zone 1 AEx db ia op is [a Ga] IIC T4 Gb							
CI, Div. 1 Group D T4, Ex ia IIA T4 Ga							AI
CI, Zone 0, AEx ia op is IIA T4 Ga							
CI, Div. 1 Groups A, B, C, D, T4, Ex ia IIC T4 Ga							CI
CI, Zone 0, AEx ia op is IIC T4 Ga							
Ex db ia op is [a Ga] IIA T4 Gb							DH
Ex db ia op is [a Ga] IIC T4 Gb							DI
Ex db eb ia op is [a Ga] IIA T4 Gb							EJ
Ex db eb ia op is [a Ga] IIC T4 Gb							EK
Ex ia op is IIA T4 Ga							IL
Ex ia op is IIC T4 Ga							IM
without							XX
IO Configuration / Data Interfaces							
3*RS485/2*FO/2*DO							1A
3*RS485/2*FO/2*DO/1*AO (Note 1)							1B
2*RS485/2*FO/2*DO/1*AO/1*HART (Slave) (Note 1)							1C
2*RS485/2*FO/2*DO/1*AO/1*Encoder (Note 1)							1D
2*RS485/2*FO/2*DO/1*AO/1*Ethernet (Note 1)							1E
2*RS485/2*FO/2*DO/1*Encoder							1J
2*RS485/2*FO/2*DO							1L
HART-p/2*RS485/2*FO/2*DO							2A
HART-p/2*RS485/2*FO/2*DO/1*AO (Note 1)							2B
HART-p/1*RS485/2*FO/2*DO/1*AO/1*HART (Slave) (Note 1)							2C
HART-p/1*RS485/2*FO/2*DO/1*AO/1*Encoder							2D
HART-p/1*RS485/2*FO/2*DO/1*AO/1*Ethernet (Note 1)							2E
Separation							
Ultrasonic Transducer (frequency / kHz, Pmax /bar, Tmax / °C)							
S2 (205, 103, 120)							S2
L2 (205, 103, 120)							L2
Z2 (205, 259, 120)							Z2
K3 (135, 16, 180)							K3
K4 (135, 63/103, 180/60)							K4
S5 (350, 103, 120)							S5
L5 (350, 103, 120)							L5
S6 (205, 103, 120)							S6
X6 (205, 103, 120)							X6
16 (205, 100, 120)							16
26 (205, 259, 120)							26
M6 (195, 10, 120)							M6
S7 (135, 20, 180)							S7
B7 (135, 16, 180)							B7
S8 (135, 103, 180)							S8
18 (135, 100, 180)							18
28 (135, 259, 180)							28
A8 (135, 63, 180)							A8
L8 (135, 250, 180)							L8
K8 (135, 63/103, 180/60)							K8
M8 (135, 10, 120)							M8
N8 (135, 63/103, 180/60)							N8
T8 (135, 103, 290)							T8
S9 (80, 16, 150)							S9
T210 (205, 103, 140)							T210
T218 (205, 103, 140)							T218
H210 (205, 103, 140)							H210
H218 (205, 103, 140)							H218
T240 (205, 400, 140)							T240

Notes:
1. in Ex ia version not available

9.7

Spare parts

Endress+Hauser recommends the following spare parts with the purchase of the gas flow meter. For a configuration with a different electronics-transducer combination, please ask your Endress+Hauser sales partner for the corresponding spare parts.

Designation	Part No.
Electronic block 200kHz / IIA / 8-path	2085291
I/O board	2085315
I/O board with Ethernet interface	2085305
Fuse I/O unit	2085302
Converter pair, type 210 for 3, 4 and 6 inch	2085302
Converter pair, type 218 from 8 inch	2080027
O-Ring set, natural gas, 7.5 * 1.5, Viton LT170-TT for T210	2085274
O-Ring set, natural gas, 15.0 * 2.0, Viton LT170-TT for T218	2085270

8029748/AE00/V2-6/2024-12

www.addresses.endress.com
