

Dresser Micro Series Volume Corrector

Model IMC/W2 Hardware Manual

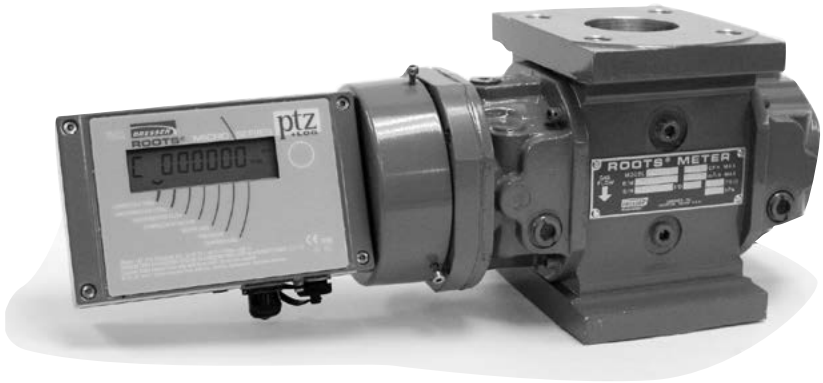

Table of Contents

1. Information	2
2. General Overview	2
2.1 Models Available	4
2.1.1 Canadian Configuration	4
2.1.2 USA Configuration	4
Table 1 – IMC/W2 Model Options Reference Table	5
2.1.3 Accessories	5
3. Specification and Details	6
3.1 Pressure Measurement	6
Table 2 – Pressure Transducer Accuracy Reference Table	6
3.2 Temperature Measurement	7
3.3 Volume Input	7
3.4 Pulse Output	7
3.5 Units of Measurement	8
3.6 Meter Dimensions	8
Figure 1 - IMC/W2 Dimensions	8
Table 3 - IMC/W2 and Meter Dimension Table	9
3.7 Serial Port	10
3.8 Display	10
Table 4 – LCD and Alarm Conditions	11
3.9 Memory	11
3.10 Internal Supply	12
3.11 Environment	12
4 Safety	13
5 Installation	13
5.1 Unpacking	13
5.2 Safety Requirements	13
5.3 EMC Compatibility	14
5.4 Mechanical Installation	14
Figure 2 – IMC/W2 Meter Mounting Guide	14
5.4.1 Setting the Weights and Measures Link	15
Figure 3 – Setting the Weights and Measure Link	16
5.5 Electrical Installation	17
5.5.1 Location of the Connection Terminals	17
Figure 4 – Location of the Connection Terminals	18
5.5.1.1 Volume Input (TB1)	19
Figure 5 – TBI Connections	19
5.5.1.2 Temperature Measurement (TB2)	20
Figure 6 – Temperature Transducer Connections (TB2)	20
5.5.1.3 Pulse Output (TB3)	21
Figure 7 – Pulse Output Connections (TB3)	21
6. Accuracy Test	20
7. Maintenance	21
7.1 Replacing the Battery Pack	22
Figure 8 - Change Battery Type	23
7.2 Pressure Transducer Recalibration	23
7.3 Temperature Recalibration	23
7.4 Restoring Factory Defaults	23
7.5 Service	23

1. Information

All printed material contained within this handbook is for information only and is subject to change without notice.

This manual uses the words corrector, corrected and uncorrected throughout. The words corrector, corrected and uncorrected should be read in Europe as meaning convertor, converted and unconverted as defined by the most recent standards on volume conversion.

In the case of the IMC/W2 T-Only and when a fixed line pressure is applied, the corrected and uncorrected volumes should be read as meaning compensated and noncompensated.

2. General Overview

The Dresser Natural Gas Solutions (NGS) Integral Micro Series Volume Corrector Model IMC/W2 combines 2 devices; an electronic counter and a volume corrector. The IMC/W2 is installed directly onto all Dresser meters and meters from certain other manufacturers. Volume is sensed from the rotation of the impellers via a Wiegand sensor, therefore the input signal to the electronic counter and volume corrector is of high resolution. This translates into extremely high accuracy volume measurement and correction. The lack of a mechanical counter increases the rangeability of the gas meter and decreases the starting flow rate of the meter.

The IMC/W2 is designed to measure live pressure and temperature to calculate corrected volume.

NOTE: a temperature only version of the IMC/W2, the IMC/W2 T-Only is also available. The IMC/W2 T-Only measures live temperature and the operator is able to configure a fixed line pressure value. All functionality, with exception of the live pressure measurement is identical to that of the IMC/W2, and the details contained within this handbook should be read as being applicable to both.

The IMC/W2 utilizes E2PROM memory which eliminates the need for back up batteries and all set up data, data and audit log entries will be stored during periods of no power. The data logging facility provides the operator with 3 independent operator configurable logging periods. The audit logging facility provides a means of tracking up to the latest 32 changes to the configuration parameters. Both the data and audit logs are saved as CSV (comma-delimited) files to allow easy import into spreadsheets such as Microsoft® Excel. For further details regarding the data and audit logging facility consult the IMC/W2 User Terminal Manual.

The IMC/W2 unit is designed (and approved intrinsically safe (I.S.) for use in hazardous areas. A serial port allows communication with the unit.

The IMC/W2 is set up and calibrated from a laptop computer via the serial port using Dresser's "Micro Corrector User Terminal" software. This will allow:

- Set up
- Calibration
- Data extraction
- Alarm monitoring

2.1 Models Available

The IMC/W2 is factory built to suit customer order requirements. Options selectable include:

- Pressure measurement (without the pressure option the unit is an IMC/W2 T-Only).
- Externally or internally mounted pressure transducer available in various ranges and in gauge or absolute.
- Pulse output via Circular connector or Gland – refer to Table 1 (IMC/W2 Model Options Reference Table) for IMC/W2 T-Only options.
- Platinum resistance thermometer (PT100) (temperature probe) – internally or externally mounted
- Canadian (read / write) or USA configuration (password) - see sections 2.1.1 (Canadian Configuration) and 2.1.2 (USA Configuration) for more details.

2.1.1 Canadian/EU Configuration

To comply with Canadian/EU Weights and Measures legislation the IMC/W2 is designed with a protection link which allows a Read Only style of communication between the operator's computer and the IMC/W2. The protection link is shipped in the Read/Write position but can be switched to the Read Only position. When in the Read Only position it is not possible to make changes to the measurement parameters without physically breaking a seal. Initial set up and configuration of the IMC/W2 will require the protection link to be placed in the Read/Write position, refer to section 5.4.1 (Setting the Weights and Measures Link).

2.1.2 USA Configuration

The position of the Weights and Measures protection link is ignored allowing all measurement parameters to be written over the serial link. Password protection is applied to these parameters.

Table 1 – IMC/W2 Model Options Reference Table

IMC/W2 Model	Line Transducer Range and Mounting Type	Pulse Options	Factory Configuration Options
PTZ + Log	2 Bar/30 PSI Gauge/Absolute Internal and External	Single Circular, Cable Gland or Conduit Type Con- nections	Password Protection Cana- dian/EU W & M Llnk Trim Table Enable/Disable
	12 Bar/180 PSI Gauge/Absolute Internal and External		
	24 Bar G - External		
	70 Bar G - External		
	70 Bar A - External		
	100 Bar A - External		
PZ + Log	Same transducer ranges as available for PTZ + Log	Single Circular, Cable Gland or Conduit Type Con- nections	Password Protection Cana- dian/EU W & M Llnk Trim Table Enable/Disable
T + Log	Not applicable	Single/Dual Circu- lar or Cable Gland or Single Conduit Type Connections	Password Protection Cana- dian/EU W & M Llnk Trim Table Enable/Disable
PTZ + Log-dp	2 Bar/30 PSI Gauge/Absolute External Mounting Only	Single Circular, Cable Gland or Conduit Type Con- nections	Password Protection Cana- dian/EU W & M Llnk Trim Table Enable/Disable
	12 Bar/180 PSI Gauge/Absolute External Mounting Only		
PZ + Log-dp	Same transducer ranges as available for PTZ + Log-dp	Single Circular, Cable Gland or Conduit Type Con- nections	Password Protection Cana- dian/EU W & M Llnk Trim Table Enable/Disable
T + log-dp	Not Applicable	Single/Dual Circu- lar or Cable Gland or Single Conduit Type Connections	Password Protection Cana- dian/EU W & M Llnk Trim Table Enable/Disable

2.1.3 Accessories

The IMC/W2 Communication Cable consists of a 2m serial link cable terminated in a 7 pin screw locking DIN plug and 9 way “D” connector.

Other additional accessories available include:

- Replacement temperature probe
- Replacement magnetic pickup or Micro Generator™

- Replacement battery pack - either alkaline or lithium options
- Spare Allen keys
- Thermowells - used for external temperature only.
- Pressure/valve piping kits

3. Specification and Details

3.1 Pressure Measurement

The IMC/W2 is fitted with a pressure transducer, mounted according to requirements. The pressure port is a 1/8" NPT male fitting. The various pressure transducers and associated percentage of accuracy are listed in Table 2 (Pressure Transducer Accuracy Reference Table).

Table 2 – Pressure Transducer Accuracy Reference Table

Pressure Transducer Range	Details
2 Bar (30 psi) A	IMC/W2 maximum error of 0.4% of reading from 0.8 Bar A to 2.0 Bar A over operating temperature range of -40°F to +140°F (-40°C to +60°C)
2 Bar (30 psi) G	IMC/W2 maximum error of 0.4% of reading from 0.8 Bar G to 2.0 Bar G over operating temperature range of -40°F to +140°F (-40°C to +60°C)
12 Bar (180 psi) A	IMC/W2 maximum error of 0.4% of reading from 1 Bar A to 12 Bar A over operating temperature range of -40°F to +140°F (-40°C to +60°C)
12 Bar (180 psi) G	IMC/W2 maximum error of 0.4% of reading from 1 Bar G to 12 Bar G over operating temperature range of -40°F to +140°F (-40°C to +60°C)
24 Bar (350 psi) G	IMC/W2 maximum error of 0.4% of reading from 1 Bar G to 24 Bar G over operating temperature range of -40°F to +140°F (-40°C to +60°C)
70 Bar (1000 psi) A	IMC/W2 maximum error of 0.4% of reading from 5 Bar A to 70 Bar A over operating temperature range of -40°F to +140°F (-40°C to +60°C)
70 Bar (1000 psi) G	IMC/W2 maximum error of 0.4% of reading from 5 Bar G to 70 Bar G over operating temperature range of -40°F to +140°F (-40°C to +60°C)
100 Bar (1500 psi) A	IMC/W2 maximum error of 0.4% of reading from 5 Bar A to 100 Bar A over operating temperature range of -40°F to +140°F (-40°C to +60°C)

The transducer burst pressure will exceed transducer range +20% for all the transducers provided.

3.2 Temperature Measurement

Temperature measurement is performed by a 4-wire Class A 100 ohm platinum resistance thermometer (temperature probe) supplied as an option with the IMC/W2. External temperature probes are available in either a 5 or a 10 foot amoured cable.

IMC/W2 accuracy for temperature is better than 0.5°C (0.9°F) over the temperature range -40°C to 60°C (-40°F to 140°F).

For connection details refer to section 5.5.1.2 (Temperature Measurement (TB2)).

3.3 Volume Input

The IMC/W2 accepts the pulses generated by the Wiegand sensor inserted as an assembly into the magnetic pick up of the Dresser meter. The following flow sensing sequences are operator configurable from within the User Terminal:

- Forward – Reverse.
- Reverse – Forward.
- Reverse.
- Forward.
- Forward + Reverse.

The value of the input pulses depends on the meter size. Dresser meters can be either meter family Series A (LMMA), Series B, Series G or high pressure. There are a number of meter models for both Series A and Series B, and this is operator configurable from within the User Terminal. For further details consult the IMC/W2 User Terminal Manual.

For connection details refer to section 5.5.1.1 (Volume Input (TB1)).

3.4 Pulse Output

There are 3 isolated Pulse outputs (uncorrected, corrected and fault), and 2 ground terminals. These ground terminals are isolated from the other ground terminals of the IMC/W2. Each output is an open drain connection capable of sinking 10mA and withstanding up to 15 Volts (5 Volts max. above +40°C or +104°F). An external “pull up” resistor or current source is normally required to ensure that the circuit will function correctly. The significance of the pulse outputs are operator configurable from within the User Terminal, and may be set independently for uncorrected and corrected volume to 0.1 / 1 / 10 / 100 / 1000 as required by the operator and as defined by meter type.

The Pulse outputs are connected to a terminal block (TB3) mounted internally and by default provide:

- Uncorrected volume pulses.
- Corrected volume pulses.
- Fault / Alarm indication.

The uncorrected and corrected outputs are isolated from each other (via GND1 (uncorrected) and GND2/3 (corrected)). The fault output shares the GND2/3 ground terminal with the corrected output.

The "ON" duration of the pulses at outputs 1 and 2 may be configured by the user to 62.5mS, 125mS, 187mS or 315mS to suit the driven equipment. The Fault/Alarm (when configured) indication will pulse at approximately 1Hz when a Fault condition is present.

The connection details for the Pulse Output is shown in section 5.5.1.3 (Pulse Output (TB3)) for standard gland connections, as an alternative (order dependent) the Amphenol connection may be fitted.

3.5 Units of Measurement

The IMC/W2 units are selectable during operator set up and can be set to imperial, metric or a combination of both in the same configuration, for example °C and cu ft. Refer to the IMC/W2 User Terminal Handbook for further details.

3.6 Meter Dimensions

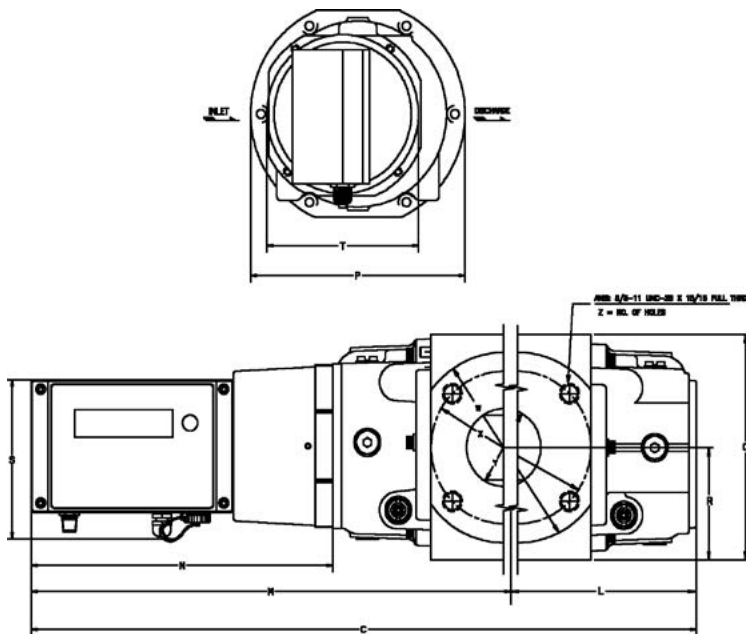

Figure 1 - (IMC/W2 and Meter Dimension Considerations)

Table 3 - IMC/W2 and Meter Dimension Table

Model	Dimensions														
	Capacity	Unit	C	L	M	N	O	P	R	S	T	W	X	Y	Z
8C	800 cfh	in	18-15/32	11-1/16	13-25/32	8-45/64	6	6-3/4	3	4-11/16	11	6	4-3/4	2-1/4	4
	22.6 m ³ /h	mm	469	119	350	221	153	172	76.5	119	280	153	120.65	37.5	4
11C	1100 cfh	in	19	4-15/16	14	8-45/64	6	6-3/4	3	4-11/16	11	6	4-3/4	2-1/4	4
	31 m ³ /h	mm	482	126	356	221	153	172	76.5	119	280	153	120.65	37.5	4
15C	1500 cfh	in	19-29/32	5-13/32	14-1/2	8-45/64	6	6-3/4	3	4-11/16	11	6	4-3/4	2-1/4	4
	42.5 m ³ /h	mm	505.5	138	368	221	153	172	76.5	119	280	153	120.65	37.5	4
G16	800 cfh	in	18-15/32	4-11/16	13-25/32	8-45/64	6	6-3/4	3	4-11/16	11	6	4-3/4	2-1/4	4
	22.6 m ³ /h	mm	469	119	350	221	153	172	76.5	119	121	153	120.65	37.5	4
G25	1412 cfh	in	19-5/64	5-13/32	13-43/64	7-7/8	6	6-3/4	3	4-11/16	4-3/4	6	4-3/4	2-1/4	4
	42.5 m ³ /h	mm	505	138	368	221	153	172	76.5	119	280	153	120.65	57.5	4
2M	2000 cfh	in	19-39/64	5-21/32	14	8-45/64	6-31/32	6-3/4	3-31/64	4-11/16	4-3/4	6	4-3/4	2-1/4	4
	57.0 m ³ /h	mm	498	144	355	221	177	172	88.5	119	121	153	120.65	37.5	4
3M	3000 cfh	in	20-27/32	6-1/4	14-39/64	8-45/64	6-31/32	6-3/4	3-31/64	4-11/16	4-3/4	6	4-3/4	2-1/4	4
	85.0 m ³ /h	mm	529	159	371	221	177	172	88.5	119	121	153	120.65	57.5	4
5M	5000 cfh	in	23-45/64	7-11/16	16	8-45/64	6-31/32	6-3/4	3-31/64	4-11/16	4-3/4	7-1/2	6	3-5/16	4
	141.5 m ³ /h	mm	602	195	407	221	177	172	88.5	119	121	190.5	152.4	84.14	4
G40	2295 cfh	in	19-39/64	5-21/32	14	8-45/64	6-31/32	6-3/4	3-31/64	4-11/16	4-3/4	6	4-3/4	2-1/4	4
	65.0 m ³ /h	mm	477	144	334	221	177	172	88.5	119	121	153	120.65	57.5	4
G65	3531 cfh	in	20-27/32	6-1/4	14-39/64	8-45/64	16-31/32	6-3/4	3-31/64	4-11/16	4-3/4	6	4-3/4	2-1/4	4
	100.0 m ³ /h	mm	529	159	371	200	177	172	88.5	119	121	153	120.65	57.5	4
G100	5650 cfh	in	23-45/64	7-11/16	16	8-45/64	6-31/32	6-3/4	3-31/64	4-11/16	4-3/4	7-1/2	6	3-5/16	4
	160.0 m ³ /h	mm	602	195	407	221	177	172	88.5	119	121	190.5	152.4	84.14	4
7M	7000 cfh	in	23-25/64	6-1/2	16-57/64	8-45/64	8-7/8	9-1/2	4-7/16	4-11/16	4-3/4	7-1/2	6	3-1/16	4
	200 m ³ /h	mm	594	165	429	221	225.4	241.3	112.7	119	121	190.5	152.4	77.8	4
G160-3"	8800 cfh	in	24-7/64	8-3/16	15-29/32	8-45/64	8-7/8	9-1/2	4-7/16	4-11/16	4-3/4	9	7-1/2	4-1/32	8
	250 m ³ /h	mm	612	208	404	221	225.4	241.3	112.7	119	121	228.6	190.5	102.4	8
G160-4"	8800 cfh	in	24-7/64	8-9/32	17-7/8	7-7/8	8-7/8	9-1/2	4-7/16	4-11/16	4-3/4	9	7-1/2	4-1/32	8
	250 m ³ /h	mm	612	211	454	200	225.4	241.3	112.7	119	121	228.6	190.5	102.4	8
11M	11,000 cfh	in	26-31/32	8-9/32	18-43/64	8-45/64	8-7/8	9-1/2	4-7/16	4-11/16	4-3/4	9	7-1/2	4-1/32	8
	310 m ³ /h	mm	685	211	475	221	225.4	241.3	112.7	119	121	228.6	190.5	102.4	8
16M	16,000 cfh	in	31-21/32	10-5/8	21	8-45/64	8-7/8	9-1/2	4-7/16	4-11/16	4-3/4	9	7-1/2	4-1/32	8
	450 m ³ /h	mm	804	270	534	221	225.4	241.3	112.7	119	121	228.6	190.5	102.4	8
G250	16,000 cfh	in	31-31/32	10-5/8	21	8-45/64	8-7/8	9-1/2	4-7/16	4-11/16	4-3/4	9	7-1/2	4-1/32	8
	450 m ³ /h	mm	804	270	534	221	225.4	241.3	112.7	119	121	228.6	190.5	102.4	8

3.7 Serial Port

The IMC/W2 is fitted with an external 7 pin screw locking DIN connector for the serial port connections. Logic levels are 5 – 12V into the IMC/W2 with a 5V nominal output from the IMC/W2 (RS232 / RS232C levels).

NOTE: There are uncorrected volume pulses available on the serial port, which are used for a prover testing of meter accuracy, see section 6 (Accuracy Tests) for further details.

3.8 Display

The LCD display is permanently active and operational over the temperature range -40°C to 60°C (-40°F to 140°F).

Depending on the particular model option chosen and the operator's configuration of the unit, the front panel selector button enables the IMC/W2 to display the following parameters:

- Corrected Volume
- Uncorrected Volume
- Flow Rate
- Correction Factor
- Meter Size**
- Line Pressure
- Temperature
- Uncorrected Volume Under Fault
- Corrected Residual
- Uncorrected Residual
- Firmware version
- Atmospheric Pressure*
- Base Pressure
- Pressure Factor
- Supercompressibility
- Battery Voltage
- Current Date
- Current Time
- Configurable Screens – Three additional parameters connected with Daily Consumption could be selected from seven options:
 - Accumulated Corrected Volume previous day,
 - Accumulated Corrected Volume current day,
 - Accumulated Corrected Volume previous month,
 - Accumulated Corrected Volume current month,
 - Highest daily volume in the previous month,
 - Highest daily volume in the current month,
 - Date of last consumption alarm.
 - Differential pressure results

*Only where applicable, i.e. if transducer is gauge

** IMC/W2's with a DP transducer fitted will show Differential Pressure in the Meter Size position. Meter Size is displayed on an alternate screen.

It is possible to specify which parameters are displayed on the LCD and which parameter is displayed by default. When shipped, the IMC/W2 will display all parameters with the Corrected Volume being default.

In alarm and / or fault conditions a message is displayed on the LCD indicating the nature of the alarm and / or fault, see table 4 (LCD and Alarm Conditions). For further information regarding the LCD consult the IMC/W2 User Terminal Handbook.

Table 3 – LCD and Alarm Conditions

LCD Alarm Code	Alarm Condition	Additional Symbols Displayed
HP AL	High Pressure alarm	N/A
LP AL	Low Pressure alarm	N/A
Ht AL	High Temperature alarm	N/A
Lt AL	Low Temperature alarm	N/A
HF AL	High Flow alarm	N/A
LF AL	Low Flow alarm	N/A
D_In_AI / tAnnPEr	Digital Input/Tamper Alarm	N/A
vol AL	High Consumption Alarm	N/A
dP AL**	Meter DP Alarm	N/A

LCD Fault Code	Fault Condition	Additional Symbols Displayed
Lo bAtt	Low Battery	Battery icon
P FLt	Pressure Fault	Alarm Bell Icon
t FLt	Temperature Fault	Alarm Bell Icon
Int FLt	Internal Operations Fault	Alarm Bell Icon
OS FLt	Ovespeed Fault	Alarm Bell Icon
Pm FLt**	DP Transducer Fault	Alarm Bell Icon
dP FLt**	Meter DP Fault	Alarm Bell Icon
dp LOC**	Meter Lockup Fault	Alarm Bell Icon
dP ZErro*	Meter DP Zero Lockup Fault	Alarm Bell Icon

** NOTE: Available only on IMC/W2 units fitted with a Differential Pressure Transducer.

3.9 Memory

The IMC/W2 has non-volatile memory and upon battery failure, will retain all of the totals obtained within the last hour of operation and all set up data. These will be available and ready for use as soon as power is restored.

Data logs (order dependant) are continually stored in the memory; the total number of logs depends on the configuration of both the log parameters and logging periods, a data log may contain any of the following information:

- Corrected Volume
- Uncorrected Volume
- Correction Factor
- Uncorrected Volume Under Fault
- Average Corrected Flow Rate
- Peak Corrected Flow Rate
- Supercompressibility
- Minimum Pressure
- Maximum Pressure
- Average Pressure
- Ending Pressure
- Minimum Temperature
- Maximum Temperature
- Average Temperature
- Ending Temperature
- Battery Voltage

For further information regarding the data logs consult the IMC/W2 User Terminal Handbook.

3.10 Internal Supply

The IMC/W2 is powered by an internal alkaline (nominal life of 5 years) or optional lithium (nominal life of 15 years) battery pack. The actual length of the battery life will depend on the conditions of use. The state of the battery is monitored and a low battery alarm is given at least 2 months before the batteries are exhausted. It is recommended that the front panel selector button is pressed before changing the battery (see section 7.1 (Replacing the Battery Pack)).

Short term power is supplied via super capacitors to allow the unit to continue to function during battery replacement.

NOTE: Change battery type and clear any faults or alarms in MCUT application.

3.11 Environment

The IMC/W2 may be operated over the following ranges:

Temperature	-40°C to 60°C (-40°F to 140°F).
Humidity	0 – 95% (condensing).
EMC	EN50081-1 and EN50082-2 Meets FCC class B requirements.
Ingress	IP66 and NEMA 4X for dust and water penetration, i.e. fully weatherproof.

4. Safety

The IMC/W2 is intrinsically safe. Class 1, Div. 1, Group A, B, C, and D locations.
Canadian Standards Association (CSA) approval number 1224451

5. Installation

5.1 Unpacking

The following items are supplied with the IMC/W2:

	Quantity
IMC/W2 Handbook	1
3mm hexagon wrench (Allen key)	1
Spacer	4
M4 x 20 cup fixing screw	3
Calibration certificate	1

The User Terminal is supplied with an additional handbook for guidance on use of the software. This is included on the User Terminal CD.

5.2 Safety Requirements

IMC/W2 installation must meet Intrinsic Safety requirements, as stated in section 4 (Safety), before beginning installation. It is essential to follow any National Codes of Practice dealing with Intrinsically Safe installations. All Intrinsically Safe circuits must be segregated from non-I.S. circuits. The transducers in the IMC/W2 are intrinsically safe.

In line with our Intrinsic Safety Certifications, the IMC/W2 must only be powered by an approved Dresser battery pack.

Connection of any non intrinsically safe equipment must be properly assessed by the user. The manufacturer (Dresser NGS) will not take responsibility for the overall safety of the system.

For commissioning and reading data the serial port may also be connected to a lap top computer under the following conditions:

- Laptop computers, generally, are not intrinsically safe. Therefore, before using an uncertified laptop in the hazardous area, a gas test should be performed to prove that no potentially hazardous gas mixture exists in the area. If this is not possible the lap top must not be used in the hazardous area.
- The laptop computer must be powered by batteries alone and these must be incapable of supplying more than 25 Volts. No connection is to be made to an external supply (e.g. charger) even if non-operational. (The presence of the connection can itself create a hazardous condition).

The temperature probe is only suitable for use at atmospheric pressure and therefore must be used in conjunction with a thermowell which is capable of withstanding the line pressure.

All individual wires connected to the circuit board must have at least 0.25mm (1/100 ins) of insulation.

5.3 EMC Compatibility

To ensure that the performance specifications are not significantly affected by electromagnetic interference, it is essential that:

- All conductors are adequately shielded using braided screens and that these screens are terminated as recommended in this manual.
- Except where stated otherwise, the length of external connections should not exceed 3m (9.57ft).
- If equipment which is not approved by the manufacturer (Dresser NGS) is connected to the IMC/W2, it is the operator's responsibility to ensure that this equipment is installed and operated in a manner which will ensure that the system is compliant with the relevant EMC standards.
- For protections against static damage, it is essential that anti-static precautions are taken when the IMC/W2 is opened for installation or maintenance.

5.4 Mechanical Installation

The IMC/W2 is mounted directly to the meter; see Figure 2 (IMC/W2 Meter Mounting Guide). Consult the factory for further installation instructions of IMC/W2 to meter body (request 056684-000 BLLN Field Installation IMCW2-To-MTR).



Figure 2 – IMC/W2 Meter Mounting Guide - Series B



Figure 2 – IMC/W2 Meter Mounting Guide - Series A

5.4.1 Setting the Weights and Measures Link

If the IMC/W2 is fitted with a weight and measure jumper, operator configuration is required to set up the unit the read/write link will need to be switched to the Read/Write position. To set the Read/Write link:

1. If the IMC/W2 is in a hazardous area the setting of the Weights and Measure Link should NOT be carried out as the PCB protection plate is removed. The set up procedure should be carried out prior to installation.
2. Remove the 4 screws securing the IMC/W2 front using the 3mm hexagon wrench (Allen key) supplied. If the 3mm hexagon wrench is not available a 7/64 ins wrench will work but may "cam out" (strip) the head making future loosening and tightening difficult.
3. Lift the front panel forward to expose the PCB protection plate that covers the main circuit board.
4. Remove the 2 PCB protection plate retaining screws (breaking the Weights and Measures seal).
5. Identify the Read/Write protection link; remove from the Read Only position and replace in the Read/Write position. Refer to Figure 3 (Setting the Weights and Measures Link).
6. The necessary parameter changes should now be carried out via the User Terminal (for further information consult the IMC/W2 User Terminal Handbook).
7. Once the necessary parameter changes have been uploaded to the unit remove the Read/Write link from Read/Write position and replace in the Read Only position.
8. Replace the 2 PCB protection plate retaining screws. Any required seal must be replaced by the appropriate authority before re-closing the unit. Normally the unit should be set up before sending it to the approval authority for the first time.
9. The IMC/W2 front panel should be offered up to the case checking that no wiring is trapped between the panel and body.
10. Reinstall the 4 front panel fixing screws and tighten these a little by hand until all screws are started. Use of anti-seizing compound is recommended.
11. Carefully hold the front panel against the body to form the seal and tighten the 4 securing screws using a 3mm hexagon wrench (Allen key). Ensure that the cables are retained within the enclosure and are not trapped in the lid seal.

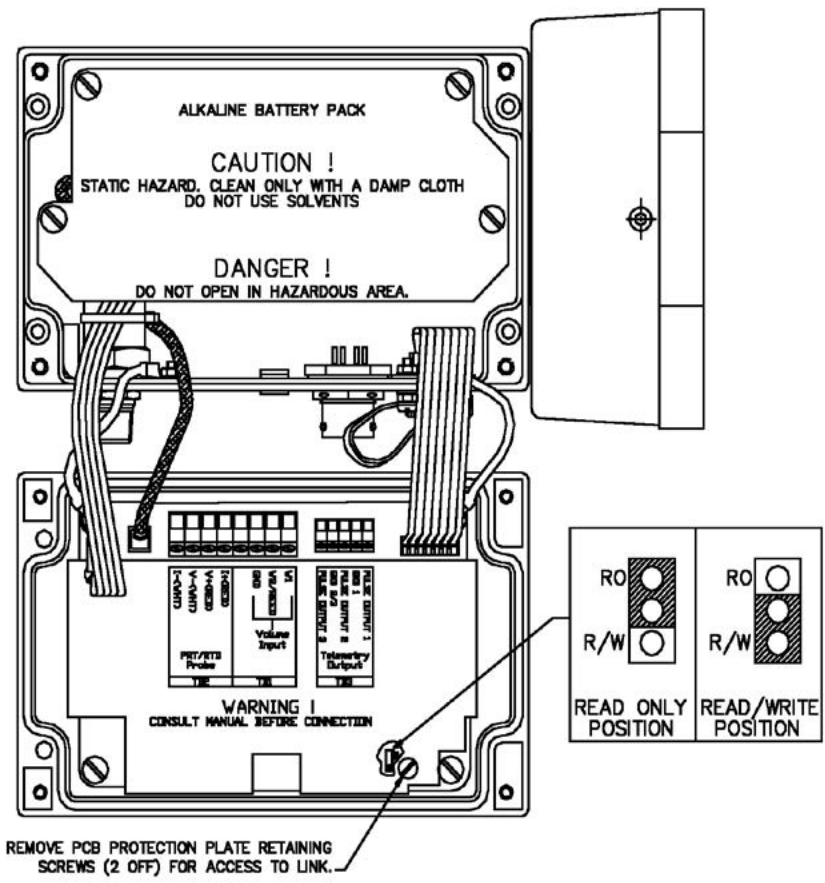

Figure 3 – Setting the Weights and Measure Link (Hardware Link).

5.5 Electrical Installation

Electrical installation should be performed by a person competent and knowledgeable about installation of intrinsically safe equipment and totally conversant with the National Code of Practice.

For protection against static damage it is essential that anti-static precautions are taken when the IMC/W2 is opened for installation or maintenance.

5.5.1 Location of the Connection Terminals

When the IMC/W2 case is opened, the location of the connections terminals will appear as in Figure 4 (Location of the Connection Terminals):

1. Remove the 4 screws securing the IMC/W2 front panel using the 3mm hexagon wrench (Allen key) supplied. If the 3mm hexagon wrench is not available a 7/64 ins wrench will work but may "cam out" (strip) the head making future loosening and tightening difficult.
2. Lift the front panel forward to expose the PCB protection plate.
3. Carry out the electrical installation as required (refer to sections 5.5.1.1 Volume Input (TB1), 5.5.1.2 Temperature Measurement (TB2) and 5.5.1.3 Pulse Output (TB3), and once complete the IMC/W2 front panel should be replaced and secured:
4. Ensure that no wiring is trapped between the panel and body prior to reinstalling the front panel.
5. Reinstall the 4 front panel mounting screws and tighten these a little by hand until all screws are started. Use of anti-seize compound is recommended.

NOTE: If the case is to be wired and sealed by the Weights and Measures authority, the 4 spacers supplied should be fitted under each head of the lid securing screws so that the wiring holes are accessible when the screws are fully tightened.

6. Carefully hold the front panel against the body to form the seal and tighten the 4 securing screws using a 3mm hexagon wrench (Allen key). Ensure that cables are retained within the enclosure and are not trapped in the lid seal.

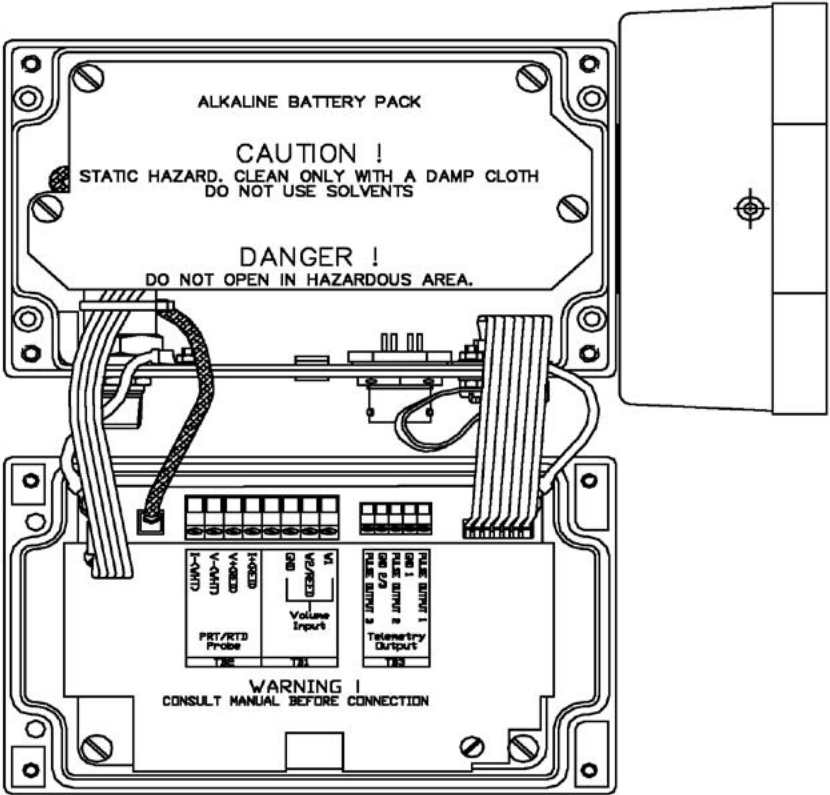

Figure 4 – Location of the Connection Terminals

5.5.1.1 Volume Input (TB1)

The mag well should be connected to the W1, W2/REED and GND Volume Input terminals of TB1, as shown in Figure 5 (Volume Input (TB1) Connections).

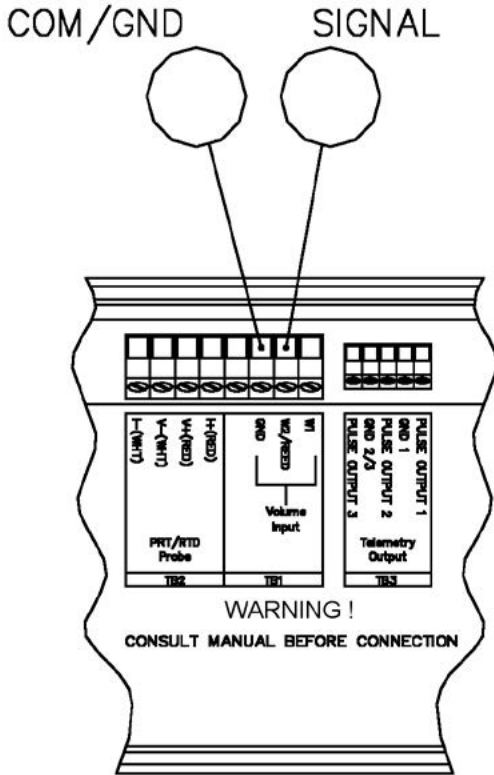

Figure 5 – TB1 Connections

5.5.1.2 Temperature Measurement (TB2)

The temperature measurement is accomplished via a temperature probe. Current is injected through a pair of connections and the voltage measured across the other pair.

The wires should be connected to the PRT/RTD Probe terminals of TB2, as shown in Figure 6 (Temperature Transducer Connections).

There are 2 pairs of wires which are essentially connected directly together inside the probe. A wire from each pair must be connected to the "I" terminals and the other wire from the same pair to the corresponding "V" terminal.

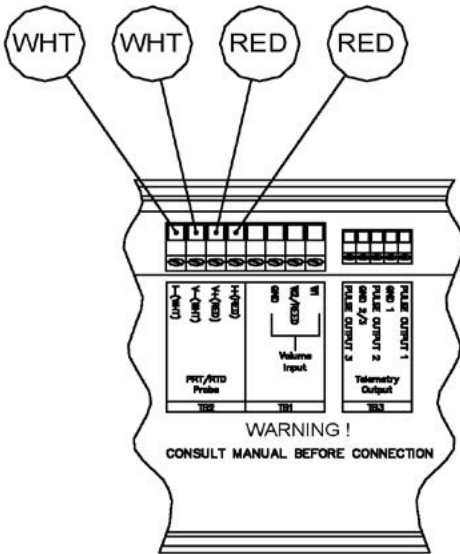

Figure 6 – Temperature Probe Connections (TB2)

5.5.1.3 Pulse Output (TB3)

Figure 7 [Pulse Output Connection (TB3)] shows the connections for the pulse output. Other Dresser approved product, such as the Chatterbox (isolation unit) may be connected to the pulse outputs. Any equipment connected to the pulse output must be individually assessed to ensure that the system is safe. The manufacturer (Dresser NGS) will not take responsibility for the overall safety of the system.

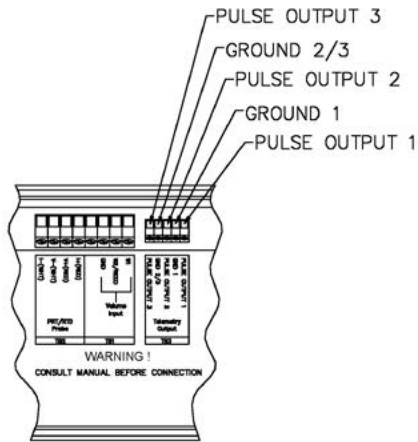

Figure 7 – Pulse Output Connections (TB3)

6. Accuracy Test

Combined accuracy test of a gas meter with IMC/W2 can be performed as described in Dresser publication: Installation/Operation/Maintenance Manual IOM: Smart Prove.

7. Maintenance

There is no requirement for routine maintenance of the IMC/W2. A pressure check may be performed by applying a known test pressure to the pressure transducer and reading the pressure value from the front panel display of the IMC/W2. The error as a percentage of reading should be calculated as follows:

$$100 \times ((P_{\text{ind}} - P_{\text{true}}) / P_{\text{true}})$$

Where P_{ind} is the indicated pressure reading on the display and P_{true} is the known measured pressure. Any difference should be less than 0.7% or such other value defined by local Weights and Measures requirements (for P_{true} higher the 20% of full scale). If this value is exceeded the IMC/W2 should be returned to the distributor so that the cause of the inaccuracy may be investigated. For further details refer to section 7.2 (Pressure Transducer Recalibration). The temperature calibration may also be performed by immersing the temperature probe into a container of liquid of a known temperature. For further details refer to section 7.3 (Temperature Transducer Recalibration).

7.1 Replacing the Battery Pack

If the low battery indication is active, the battery pack should be changed within the next 2 months.

IMC/W2's should not be left with discharged packs inside them as discharged cells are more prone to leak than are new or partially used cells. If the IMC/W2 is to be stored for any length of time, the battery pack should be removed and stored separately.

If the internal battery voltage is low, the battery icon will be displayed when the front panel button is pressed. The icon will be present until display test is selected or the default corrected total display is set or the battery voltage rises above the low threshold. NOTE: The low battery fault latch will only be set when the battery voltage has been low for 24 consecutive hours.

Before replacing the battery pack press the front panel selector button on the IMC/W2. This operation ensures that the latest corrected and uncorrected totals are stored in the permanent memory of the IMC/W2. Super capacitors will maintain normal operation of the unit during battery replacement.

For protection against static damage, it is essential that anti-static precautions are taken when the IMC/W2 is opened.

The battery pack affects the intrinsic safety of the IMC/W2 and must be replaced with the correct Dresser battery pack. To replace the battery pack:

1. Press the front panel selector button on the front of the IMC/W2.
2. Unscrew the 4 screws holding the front panel of the IMC/W2 using a hexagon wrench or suitable Allen key (as described in section 5.5 Electrical Installation).
3. Unplug the battery connector from the main circuit board mounted behind the front panel.
4. Use a screw driver to remove the 4 screws (and 4 washers) holding the battery pack.
5. Remove the old battery pack.
6. Place the new battery pack in to position and replace the 4 screws and 4 washers.
7. Plug the new battery pack into the main circuit board, such that the battery plug engages correctly with the connector locking ramp on the circuit board.
8. Check that the IMC/W2 displays the default parameter of the LCD and the normal operation has resumed.
9. Carefully dress the battery lead and the other wirings so that they will not be trapped between the enclosure and front panel.
10. Replace and retighten the screws holding the front panel as described in section 5.4 Mechanical Installation.

NOTE: Observe any local regulations on disposal of the battery pack.

NOTE: If the battery is changed then be sure to change the battery type (alkaline or lithium) by connecting with serial cable and MCUT application (Figure 8).



Figure 8 – Battery Type

7.2 Pressure Transducer Calibration

Recalibration of the pressure transducer should not be required however, the IMC/W2 may be pressure calibrated by the operator, using the serial port of the IMC/W2 and the User Terminal software. It is possible to calibrate either the zero only or both the zero and the span.

NOTE: During the pressure calibration process multiple temperature readings are automatically compared over a period to ensure that the readings are stable. If stability is not obtained the calibration process will not be successful.

For further details regarding the pressure calibration refer to the IMC/W2 User Terminal Handbook.

7.3 Temperature Calibration

Temperature recalibration should not be required however, the IMC/W2 may be temperature calibrated by the operator, using the serial port of the IMC/W2 and the User Terminal software.

To obtain temperature calibration points use one of the following methods:

Use temperature controlled baths with the IMC/W2 temperature probe and a calibrated thermometer for determining the bath temperatures. As an alternative use a vacuum flask filled with liquid which is well stirred, and place the temperature probe and calibrated thermometer in this.

OR

Simulate the temperature probe using a calibrated resistance box set to values corresponding to 2 different temperatures. If this option is chosen the temperature probe must be disconnected from the IMC/W2 and the resistance box must be connected as a 4 wire resistor in its place.

NOTE: During the temperature calibration process multiple temperature readings are automatically compared over a period to ensure that the readings are stable. If stability is not obtained the calibration process will not be successful.

For further details regarding the temperature calibration refer to the IMC/W2 User Terminal Handbook, alternatively contact your distributor.

7.4 Restoring Factory Defaults

It is possible to restore the factory defaults for pressure and temperature from within the User Terminal Manual.

7.5 Service

There are no user replaceable parts with the exception of the temperature probe and the battery pack.

Repair of the circuit board itself should not be attempted as this may invalidate I.S. approval of the product.

Dresser Meters & Instruments
16240 Port Northwest Drive
Houston, TX 77041
T: 1-800-521-1114
F: 1-800-335-5224

*© 2018 Natural Gas Solutions North America, LLC
– All rights reserved. Natural Gas Solutions reserves
the right to make changes in specifications and
features shown herein, or discontinue the product
described at any time without notice or obligation.
Contact your Dresser Natural Gas Solutions
representative for the most current information. The
Dresser Logo and all Trademarks containing the
term "Dresser" are the property of Dresser, LLC, a
subsidiary of Baker Hughes, a GE Company.*



www.dresserngs.com